

# TP 2012 Series

## Multilayer Chip Triplexers

### Features

- ❖ Monolithic structure including one low-pass and two band-pass filters with loss pole at adjacent passband
- ❖ RoHS compliant



### Applications

- ❖ Triple-band for GPS and 2.4GHz/5GHz WLAN

### Specifications

Part Number	Passband (MHz)	Insertion Loss (dB)	Return Loss (dB)	Attenuation (dB)	Isolation (dB)
<b>TP2012-A1255BA</b>	1560 ~ 1610	0.6 max. @25°C 0.7 max. @-40~85°C	10 min.	14 min. @ 2400 ~ 2500 MHz 15 min. @ 4800 ~ 6000 MHz	Low to Middle band @ 1559~1606 20 min.
	2400 ~ 2500	0.73 max. @25°C 0.81 max. @-40~85°C	10 min.	10 min. @ 3600 ~ 3750 MHz 20 min. @ 4800 ~ 5000 MHz 10 min. @ 7200 ~7500 MHz 10 min. @ 9600 ~10000 MHz	Middle to High band @ 4800~5000 20 min.
	4900 ~ 5950	0.8 max @25°C 0.92 max @-40~85°C	10 min.	24 min. @ 860 ~ 960 MHz 24 min. @ 1545 ~ 1605 MHz 25 min. @ 1710 ~ 1990 MHz 30 min. @ 2170 MHz 10 min. @ 8100 ~ 8800 MHz 15 min. @ 8820 ~ 9800 MHz 25 min. @ 9800 ~ 11800 MHz	Low to High band @ 1559~1606 25 min.

Q'ty/Reel (pcs) : 4,000  
 Operating Temperature Range : -40 ~ +85 °C  
 Storage Temperature Range : -40 ~ +85 °C  
 Storage Period : 12 months max.  
 Power Capacity : 2W max.

## Part Number

TP   2012   -   A   1255   BA   □   /LF  
 ①   ②   ③   ④   ⑤   ⑥   ⑦

① Type	TP : Triplexer	② Dimensions ( L x W )	2.0 x 1.2 mm
③ Material Code	A	④ Frequency Range	1255=1610MHz /2450MHz /5500MHz
⑤ Specification Code	BA	⑥ Packaging	T: Tape & Reel B: Bulk
⑦ Soldering	/LF=lead-free		

## Terminal Configuration

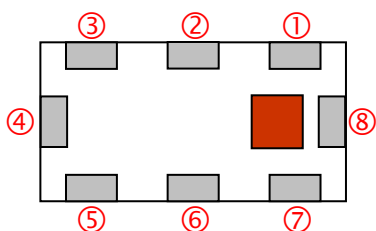

No.	Terminal Name	No.	Terminal Name
①	GND	⑤	GND
②	Common Port	⑥	High-Band Port (5G)
③	GND	⑦	GND
④	Middle-Band Port (2.4G)	⑧	Low-Band Port (1.5G)

## Dimensions and Recommended PC Board Pattern

Unit : mm

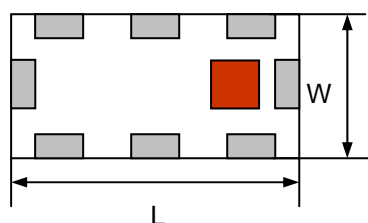

< Top View >

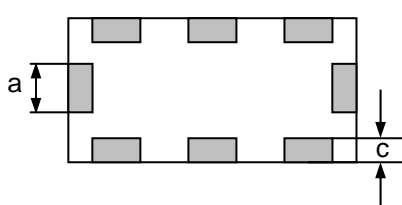

< Bottom View >

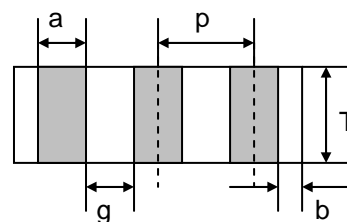

< Side View >

Mark	L	W	T	a	b	c	g	p
Dimensions	2.0 ±0.1	1.25 ±0.1	0.95 ±0.1	0.3 ± 0.1	0.2 ± 0.1	0.3+0.1 /-0.2	0.35 ± 0.1	0.65 ± 0.05

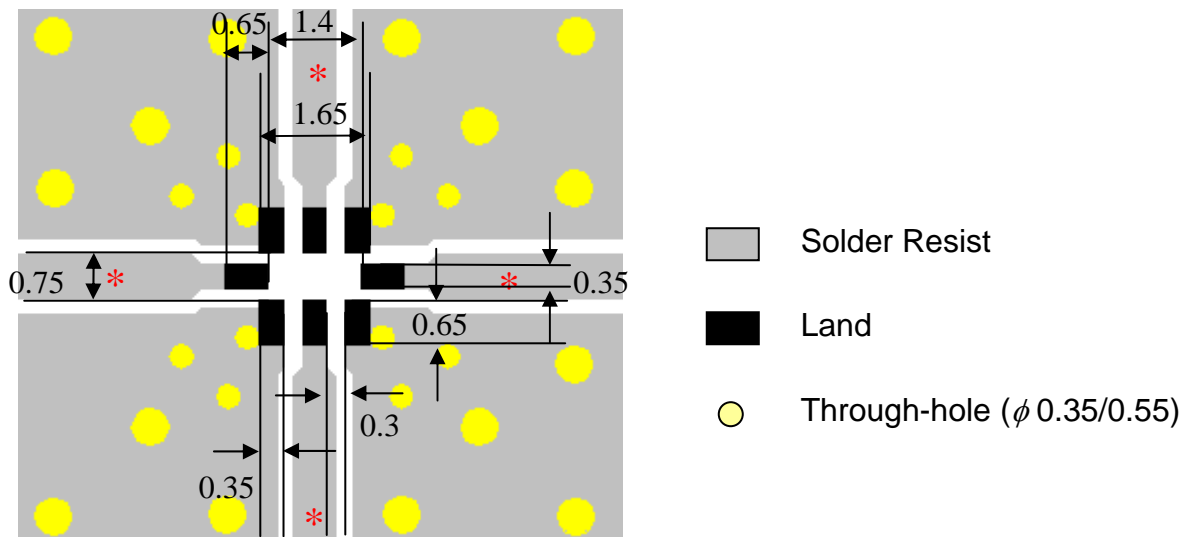

\* Line width should be designed to match 50Ω characteristic impedance, depending on PCB material and thickness.

### Measuring Diagram

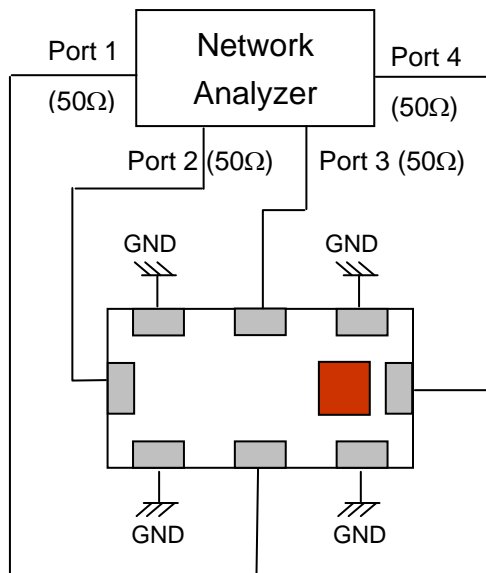

\*In Application, It is not necessary to add the DC blocking capacitors at all ports when DC voltages are present at these RF ports.

**Typical Electrical Characteristics (T=25°C)**

**Attenuation**

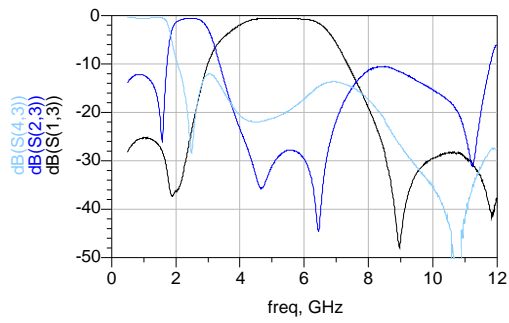

**Return Loss**

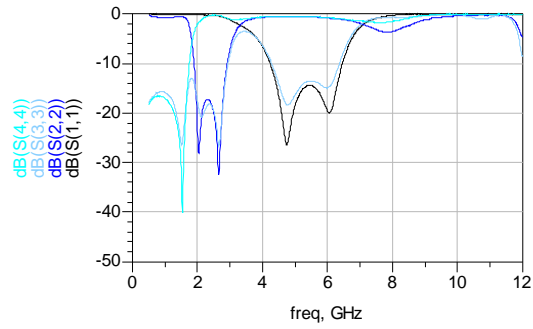

**Notes**

❖ The contents of this data sheet are subject to change without notice. Please confirm the specifications and delivery conditions when placing your order.

## Taping Specifications

### ❖Tape Dimensions (Unit: mm) & Quantity

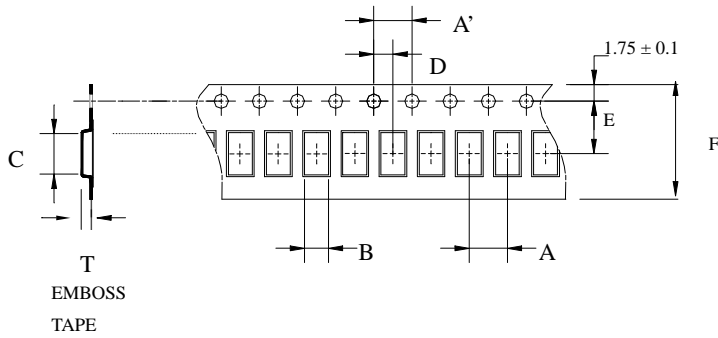

Type	A	A'	B	C	D	E	F	T	Quantity/reel	Tape material
2012	4.0±	4.0±	1.35±	2.15±	2.0±	3.5±	8.0±	1.08±	4,000pcs	Plastic (Embossed)
	0.1	0.1	0.05	0.05	0.05	0.1	0.1	0.05		

### ❖Reel Dimensions (Unit: mm)

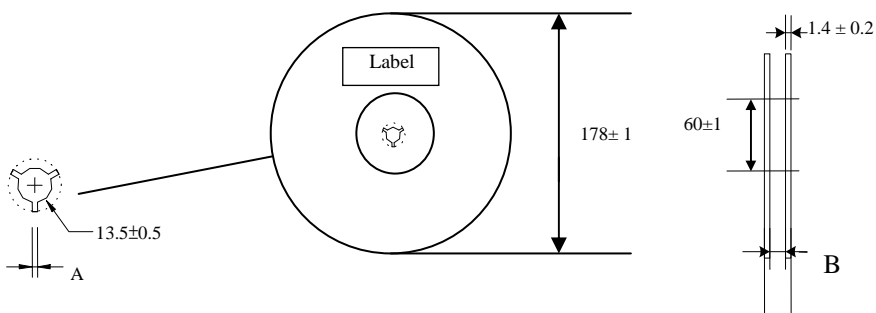

Label: Customer's Name,  
ACX P/N, Q'ty, Date,  
ACX Corp.

Type	A	B
2012	2.3±0.5	9.0±0.3

### ❖Leader and Trailer Tape

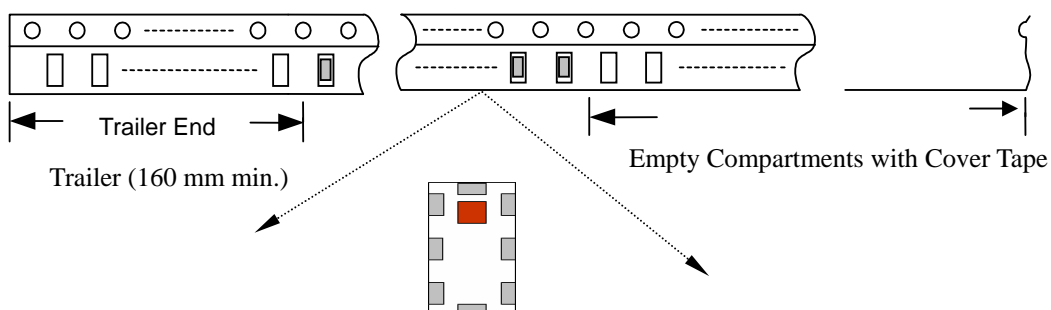

❖ **Peel-off Force**

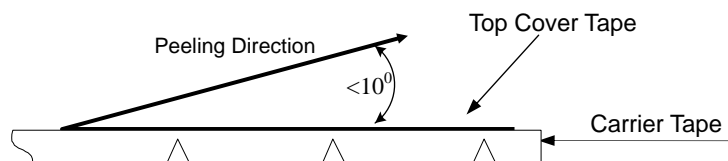

Peel-off force should be in the range of 0.1 – 0.6 N at a peel-off speed of  $300 \pm 10$  mm/min .

❖ **Storage Conditions**

- (1) Temperature:  $+5 \sim +35^{\circ}\text{C}$ , relative humidity (RH): 45~75%.
- (2) Non-corrosive environment.

**Notes**

❖ The contents of this data sheet are subject to change without notice. Please confirm the specifications and delivery conditions when placing your order.

## Mechanical & Environmental Characteristics

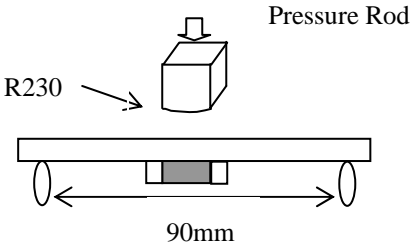
Item	Requirements	Procedure
Solderability	<ol style="list-style-type: none"> <li>No apparent damage</li> <li>More than 95% of the terminal electrode shall be covered with new solder.</li> </ol>	<ol style="list-style-type: none"> <li>Preheat: <math>120 \pm 5^\circ\text{C}</math></li> <li>Solder: <math>245 \pm 5^\circ\text{C}</math> for <math>5 \pm 1</math> sec</li> </ol>
Soldering strength (Termination Adhesion)	<ol style="list-style-type: none"> <li>10N minimum</li> </ol>	<ol style="list-style-type: none"> <li>Solder specimen onto test jig.</li> <li>Apply push force at 0.5mm/s until electrode pads are peeled off or ceramic are broken. Pushing force is applied to longitude direction</li> </ol>
Deflection (Substrate Bending)	<ol style="list-style-type: none"> <li>No apparent damage</li> <li>Fulfill the electrical specification</li> </ol>	<ol style="list-style-type: none"> <li>Solder specimen onto test jig (FR4, 0.8mm) using the recommend soldering profile.</li> <li>Apply a bending force of 2mm deflection</li> </ol> 
Heat/Humidity Resistance	<ol style="list-style-type: none"> <li>No apparent damage</li> <li>Fulfill the electrical specification after test</li> </ol>	<ol style="list-style-type: none"> <li>Temperature: <math>85 \pm 2^\circ\text{C}</math></li> <li>Humidity: 90% ~ 95% RH</li> <li>Duration: <math>1000 \pm 48</math>hrs</li> <li>Recovery: 1-2hrs</li> </ol>
Thermal shock (Temperature Cycle)	<ol style="list-style-type: none"> <li>No apparent damage</li> <li>Fulfill the electrical specification after test</li> </ol>	<ol style="list-style-type: none"> <li>One cycle/step 1 : <math>125 \pm 5^\circ\text{C}</math> for 30 min step 2 : <math>-40 \pm 5^\circ\text{C}</math> for 30 min</li> <li>No of cycles : 100</li> <li>Recovery: 1-2 hrs</li> </ol>
Low Temperature Resistance	<ol style="list-style-type: none"> <li>No apparent damage</li> <li>Fulfill the electrical specification after test</li> </ol>	<ol style="list-style-type: none"> <li>Temperature: <math>-40 \pm 5^\circ\text{C}</math></li> <li>Duration: <math>500 \pm 24</math>hrs</li> <li>Recovery: 1-2hrs</li> </ol>

## Soldering Conditions

### ❖ Typical Soldering Profile for Lead-free Process

Reflow Soldering :

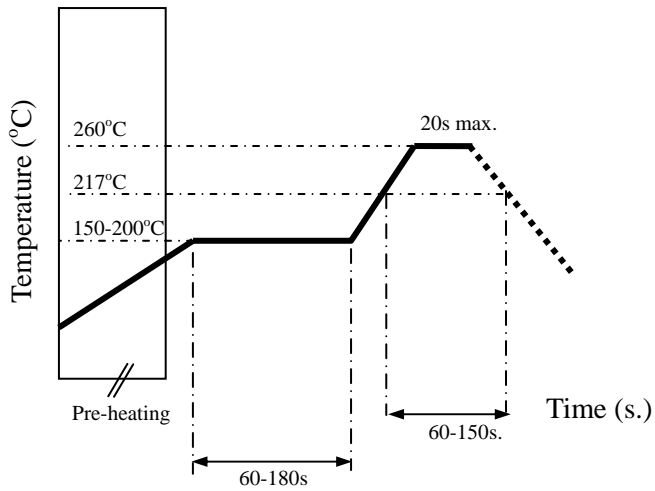

## Notes

❖ The contents of this data sheet are subject to change without notice. Please confirm the specifications and delivery conditions when placing your order.

### **Advanced Ceramic X Corp.**

16 Tzu Chiang Road, Hsinchu Industrial District Hsinchu Hsien 303, Taiwan

TEL:886-3-5987008 FAX:886-3-5987001

E-mail: [acx@acxc.com.tw](mailto:acx@acxc.com.tw)

<http://www.acxc.com.tw>