

LF 1608 Series

Multilayer Chip Low-Pass Filters

Features

- ❖ Monolithic structure replacing one inductor and three capacitors.
- ❖ RoHS compliant

Applications

- ❖ 0.8-6GHz wireless communication systems, including DECT / PACS / PHS / GSM / DCS / PCS phones, WLAN card, Bluetooth modules, etc.



Specifications

Part Number	Frequency Range (MHz)	Insertion Loss @ BW (dB)	Attenuation @ 2 x f _o (dB)	Attenuation @ 3 x f _o (dB)	VSWR @ BW	Q'ty/ Reel (pcs)
LF1608-B2R4KCB_	2400-2500	0.50 max.	35 min.	25 min.	1.5 max.	4,000

Operating Temperature Range : -40 ~ +85 °C
 Storage Temperature Range : +5 ~ +35 °C, Humidity 45~75%RH
 Storage Period : 12 months max.
 Power Capacity : 2W max.

Part Number

LF 1608 - B 2R4 KCB □ /LF
 ① ② ③ ④ ⑤ ⑥ ⑦

① Type	LF : Low Pass Filter	② Dimensions (L x W)	1.6 x 0.8 mm
③ Material Code	B	④ Frequency Range	2R4=2400MHz
⑤ Specification Code	KCB	⑥ Packaging	T: Tape & Reel B: Bulk
⑦ Soldering	/LF=lead-free		

Terminal Configuration

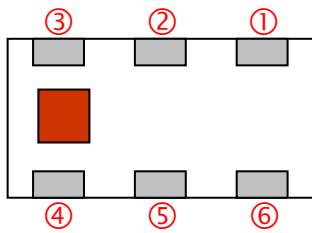

No.	Terminal Name	No.	Terminal Name
①	GND	④	GND
②	IN	⑤	OUT
③	GND	⑥	GND

Dimensions and Recommended PC Board Pattern

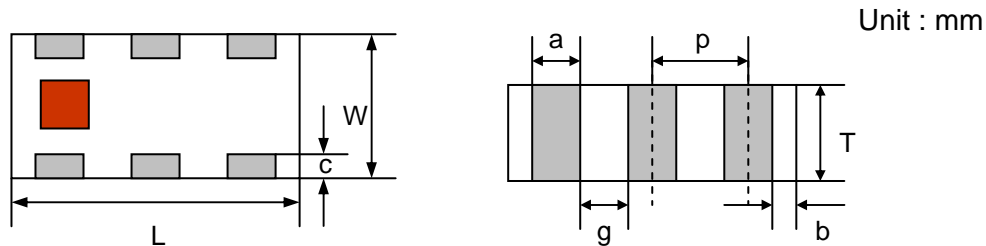

Mark	L	W	T	a	b	c	g	p
Dimensions	1.6 ±	0.8 ±	0.6 ±	0.2 ±	0.2+0.1	0.15 ±	0.3 ±	0.50 ±
	0.1	0.1	0.1	0.1	/-0.15	0.1	0.1	0.05

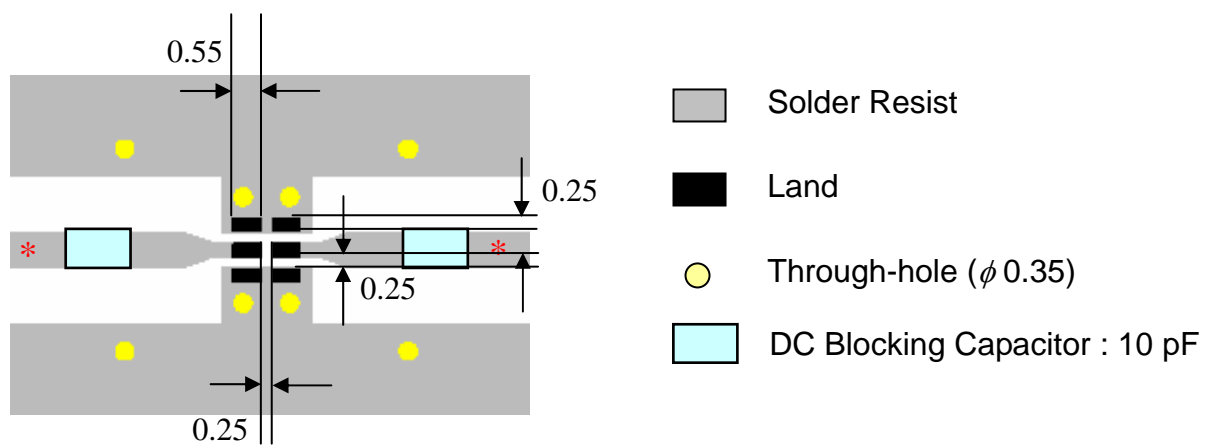

* Line width should be designed to match 50 Ω characteristic impedance, depending on PCB material and thickness.

* DC Blocking capacitor is connected in series at each In/Out Port.

Measuring Diagram

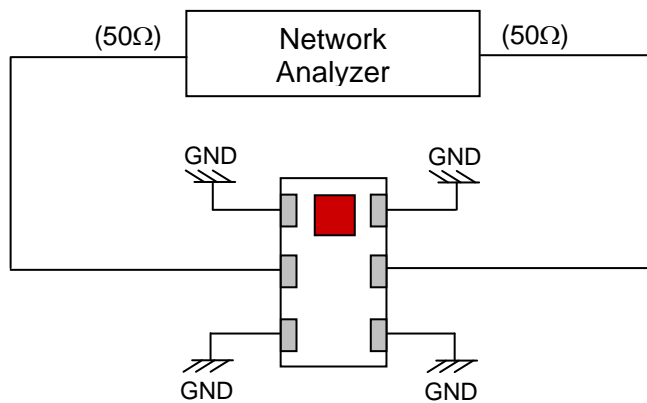

Typical Electrical Characteristics(T=25°C)

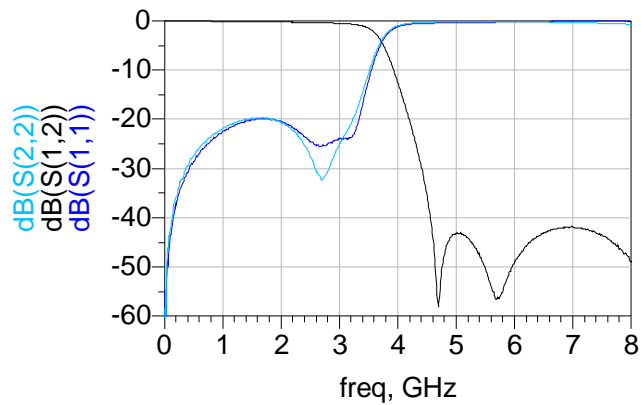

Notes

- ❖ The contents of this data sheet are subject to change without notice. Please confirm the specifications and delivery conditions when placing your order.

Taping Specifications

❖Tape Dimensions (Unit: mm) & Quantity

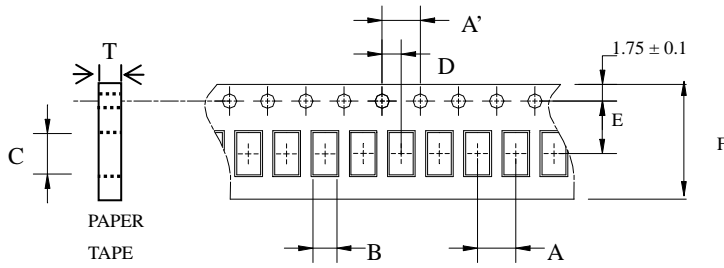

Type	A	A'	B	C	D	E	F	T	Quantity/reel	Tape material
1608	4.0±	4.0±	1.10±	1.92±	2.0±	3.5±	8.0±	0.75±	4,000pcs	Paper
	0.1	0.1	0.1	0.1	0.1	0.1	0.1	0.05		

❖Reel Dimensions (Unit: mm)

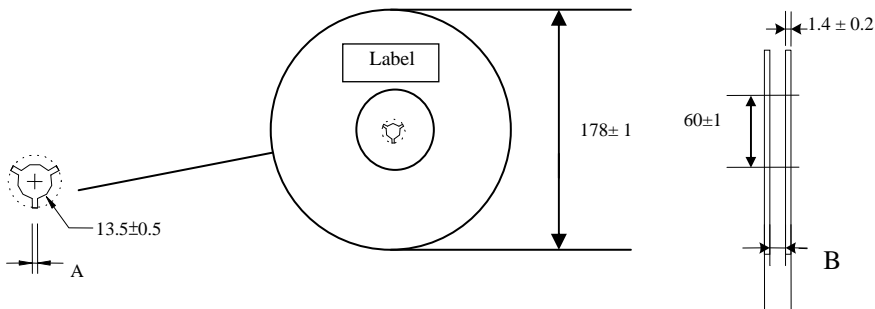

Label: Customer's Name,
ACX P/N, Q'ty, Date,
ACX Corp.

Type	A	B
1608	2.3±0.5	9.0±0.3

❖Leader and Trailer Tape

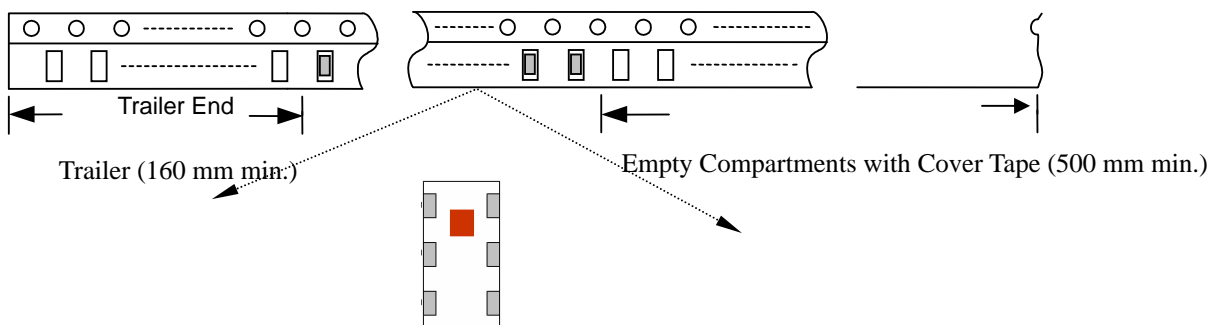

❖ **Peel-off Force**

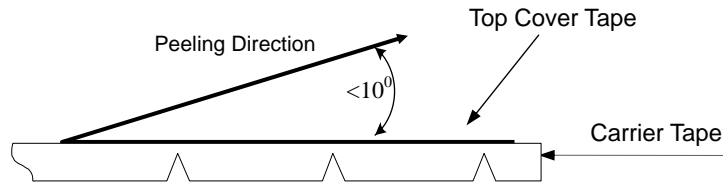

Peel-off force should be in the range of 0.1 – 0.6 N at a peel-off speed of 300 ± 10 mm/min .

❖ **Storage Conditions**

- (1) Temperature: 15 ~35°C , relative humidity (RH): 45~75%.
- (2) Non-corrosive environment.

Notes

- ❖ The contents of this data sheet are subject to change without notice. Please confirm the specifications and delivery conditions when placing your order.

Mechanical & Environmental Characteristics

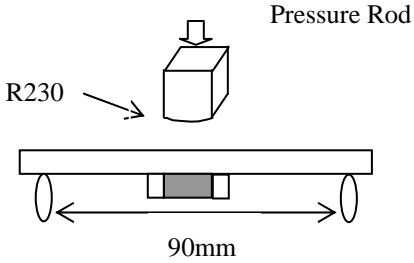
Item	Requirements	Procedure
Solderability	<ol style="list-style-type: none"> No apparent damage More than 95% of the terminal electrode shall be covered with new solder 	<ol style="list-style-type: none"> Preheat: $120 \pm 5^\circ\text{C}$ Solder: $245 \pm 5^\circ\text{C}$ for 5 ± 1 sec
Soldering strength (Termination Adhesion)	<ol style="list-style-type: none"> 1kg minimum 	<ol style="list-style-type: none"> Solder specimen onto test jig. Apply push force at 0.5mm/s until electrode pads are peeled off or ceramic are broken. Pushing force is applied to longitude direction
Deflection (Substrate Bending)	<ol style="list-style-type: none"> No apparent damage 	<ol style="list-style-type: none"> Solder specimen onto test jig (FR4, 0.8mm) using the recommend soldering profile. Apply a bending force of 2mm deflection 
Heat/Humidity Resistance	<ol style="list-style-type: none"> No apparent damage Fulfill the electrical specification after test 	<ol style="list-style-type: none"> Temperature: $85 \pm 2^\circ\text{C}$ Humidity: 90% ~ 95% RH Duration: 1000 ± 48hrs Recovery: 1-2hrs
Thermal shock (Temperature Cycle)	<ol style="list-style-type: none"> No apparent damage Fulfill the electrical specification after test 	<ol style="list-style-type: none"> One cycle/step 1 : $125 \pm 5^\circ\text{C}$ for 30 min step 2 : $-40 \pm 5^\circ\text{C}$ for 30 min No of cycles : 100 Recovery: 1-2 hrs
Low Temperature Resistance	<ol style="list-style-type: none"> No apparent damage Fulfill the electrical specification after test 	<ol style="list-style-type: none"> Temperature: $-40 \pm 5^\circ\text{C}$ Duration: 500 ± 24hrs Recovery: 1-2hrs

Soldering Conditions

❖ Typical Soldering Profile for Lead-free Process

Reflow Soldering :

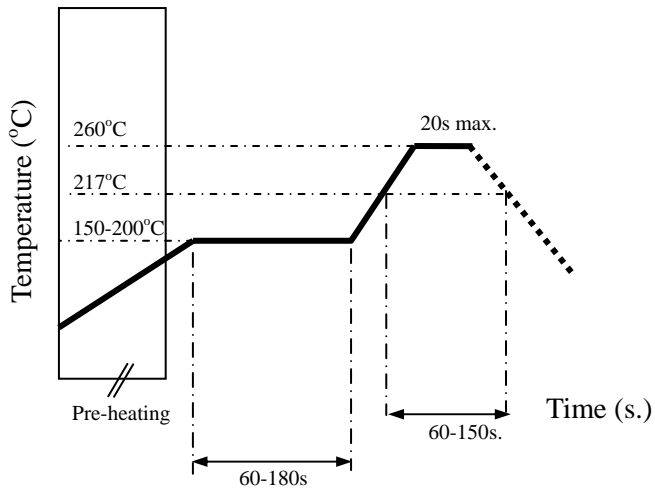

Notes

❖ The contents of this data sheet are subject to change without notice. Please confirm the specifications and delivery conditions when placing your order.

Advanced Ceramic X Corp.

16 Tzu Chiang Road, Hsinchu Industrial District Hsinchu Hsien 303, Taiwan

TEL:886-3-5987008 FAX:886-3-5987001

E-mail: acx@acxc.com.tw

<http://www.acxc.com.tw>