

DP 1608 Series

Multilayer Chip Diplexers

Features

- ❖ Monolithic structure including two band-pass filters with loss pole at adjacent passband.
- ❖ RoHS compliant.

Applications

- ❖ Dual-band / dual-mode 2.4GHz/5GHz WLAN.

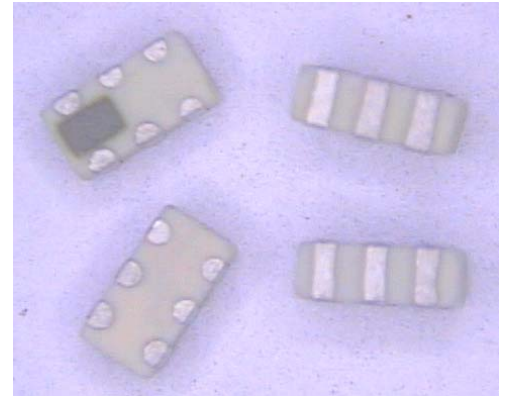

Specifications

Part Number	Passband (MHz)	Insertion Loss (dB)	Return Loss (dB)	Attenuation (dB)	Isolation (dB)
DP1608-R2461BLQ1	2400~2500	1.15 max. @25°C 1.35 max. @-40~105 °C	10 min.	15 min. @30~1000MHz 33 min. @4800~7125MHz 35 min. @7200~7500MHz 20 min. @7500~12000MHz	30 min. @2400~2500MHz 30 min. @5150~7125MHz
	5150~7125	1.25 max. @25°C 1.45 max. @-40~105 °C	10 min.	20 min. @10~2300MHz 30 min. @2400~2500MHz 20 min. @2700~3500MHz 25 min. @9800~14250MHz 12 min. @14700~21375MHz	10 min. @15000~18000MHz

Q'ty/Reel (pcs) : 4000
 Operating Temperature Range : -40 ~ +105 °C
 Storage Temperature Range : -40 ~ +105 °C
 Storage Period : 12 months max.
 Power Capacity : 3W max.

Part Number

DP 1608 - R 2461 BLQ1 □ /LF
 ① ② ③ ④ ⑤ ⑥ ⑦

① Type	DP : Diplexer	② Dimensions (L x W)	1.6 x 0.8 mm
③ Material Code	R	④ Frequency Range	2461=2450MHz /6100MHz
⑤ Specification Code	BLQ1	⑥ Packaging	T: Tape & Reel B: Bulk
⑦ Soldering	/LF=lead-free		

Terminal Configuration

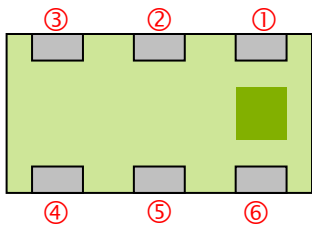

No.	Terminal Name	No.	Terminal Name
①	Higher Freq. Port	④	GND
②	GND	⑤	Common Port
③	Lower Freq. Port	⑥	GND

Dimensions and Recommended PC Board Pattern

Unit : mm

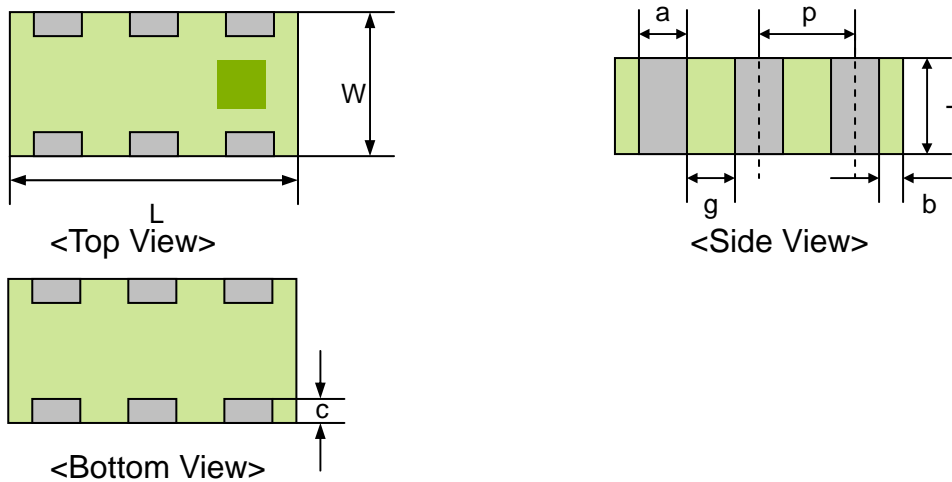

Mark	L	W	T	a	b	c	g	p
Dimensions	1.6±0.1	0.8±0.1	0.7max.	0.2±0.1	0.2+0.1 /-0.15	0.15±0.1	0.3±0.1	0.5±0.05

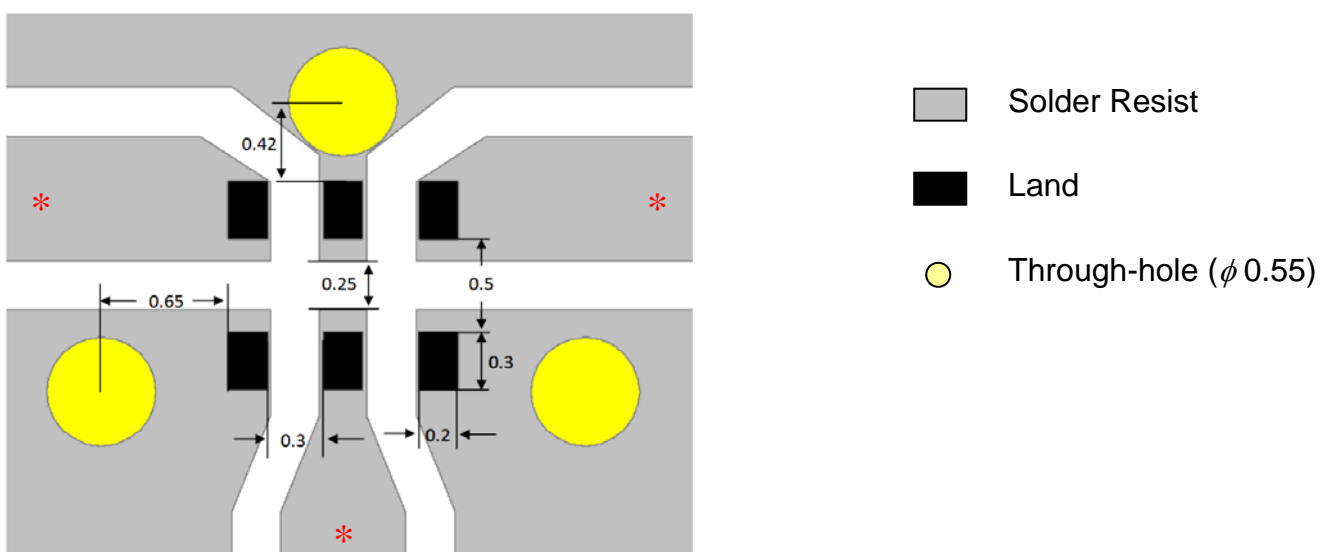

* Line width should be designed to match 50ohm characteristic impedance, depending on PCB material and thickness.

Measuring Diagram

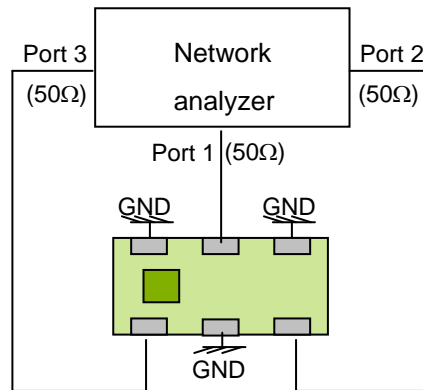

Electrical Characteristics (T=25°C)

Attenuation

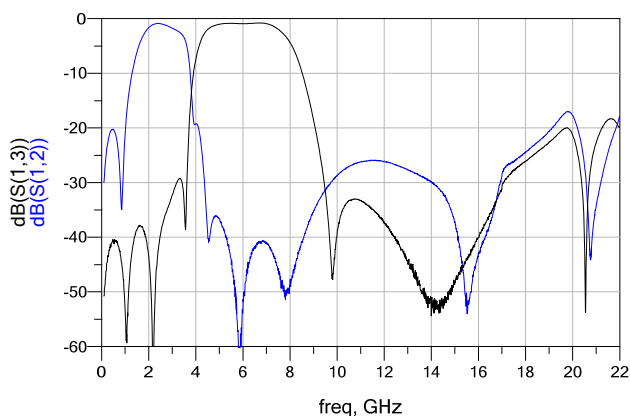

Return Loss

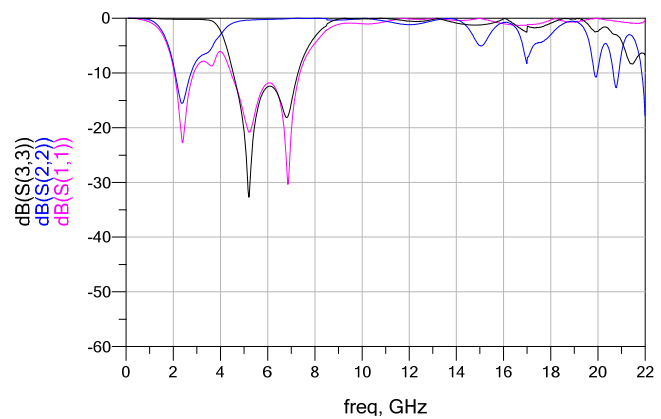

Isolation

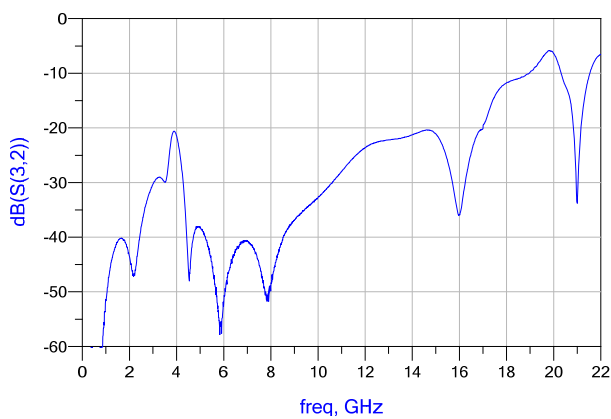

Notes

- ❖ The contents of this data sheet are subject to change without notice. Please confirm the specifications and delivery conditions when placing your order.

Taping Specifications

❖Tape Dimensions (Unit: mm) & Quantity

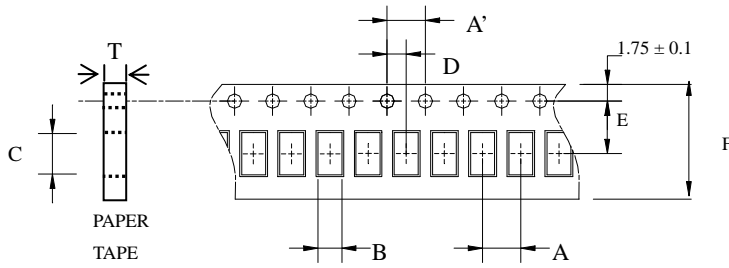

Type	A	A'	B	C	D	E	F	T	Quantity/reel	Tape material
1608	4.0±	4.0±	1.10±	1.92±	2.0±	3.5±	8.0±	0.75±	4,000pcs	Paper
	0.1	0.1	0.1	0.1	0.1	0.1	0.1	0.05		

❖Reel Dimensions (Unit: mm)

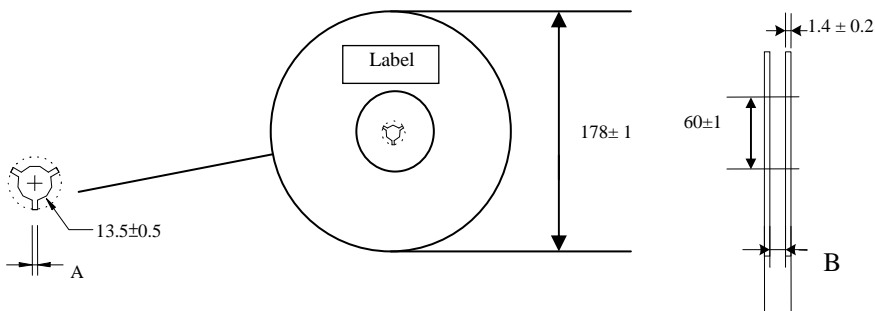

Label: Customer's Name,
ACX P/N, Q'ty, Date,
ACX Corp.

Type	A	B
1608	2.3±0.5	9.0±0.3

❖Leader and Trailer Tape

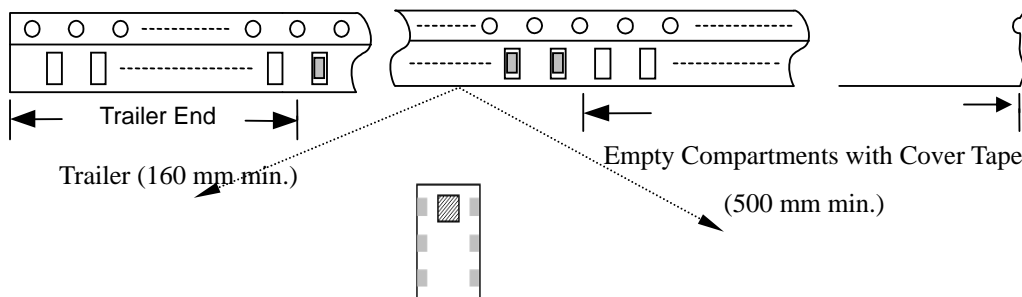

❖ **Peel-off Force**

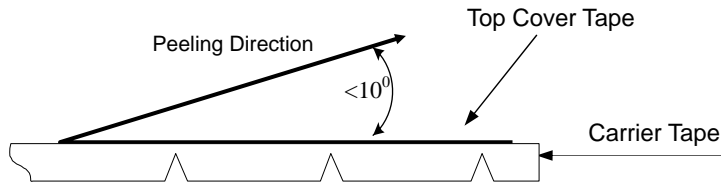

Peel-off force should be in the range of 0.1 – 0.6 N at a peel-off speed of 300 ± 10 mm/min .

❖ **Storage Conditions**

- (1) Temperature: 5 ~35°C , relative humidity (RH): 45~75%.
- (2) Non-corrosive environment.

Notes

- ❖ The contents of this data sheet are subject to change without notice. Please confirm the specifications and delivery conditions when placing your order.

Mechanical & Environmental Characteristics

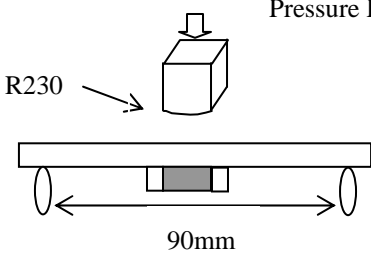
Item	Requirements	Procedure
Solderability	<ol style="list-style-type: none"> No apparent damage More than 95% of the terminal electrode shall be covered with new solder 	<ol style="list-style-type: none"> Preheat: $120 \pm 5^{\circ}\text{C}$ Solder: $245 \pm 5^{\circ}\text{C}$ for 5 ± 1 sec
Soldering strength (Termination Adhesion)	<ol style="list-style-type: none"> 10N minimum 	<ol style="list-style-type: none"> Solder specimen onto test jig. Apply push force at 0.5mm/s until electrode pads are peeled off or ceramic are broken. Pushing force is applied to longitude direction.
Deflection (Substrate Bending)	<ol style="list-style-type: none"> No apparent damage 	<ol style="list-style-type: none"> Solder specimen onto test jig (FR4, 1.6mm) using the recommend soldering profile. Apply a bending force of 2mm deflection. 
Heat/Humidity Resistance	<ol style="list-style-type: none"> No apparent damage Fulfill the electrical specification after test 	<ol style="list-style-type: none"> Temperature: $85 \pm 2^{\circ}\text{C}$ Humidity: 90% ~ 95% RH Duration: 1000 ± 48hrs Recovery: 1-2hrs
Thermal shock (Temperature Cycle)	<ol style="list-style-type: none"> No apparent damage Fulfill the electrical specification after test 	<ol style="list-style-type: none"> One cycle/step 1 : $125 \pm 5^{\circ}\text{C}$ for 30 min step 2 : $-40 \pm 5^{\circ}\text{C}$ for 30 min No of cycles : 100 Recovery: 1-2 hrs
Low Temperature Resistance	<ol style="list-style-type: none"> No apparent damage Fulfill the electrical specification after test 	<ol style="list-style-type: none"> Temperature: $-40 \pm 5^{\circ}\text{C}$ Duration: 500 ± 24hrs Recovery: 1-2hrs

Soldering Conditions

❖ Typical Soldering Profile for Lead-free Process

Reflow Soldering :

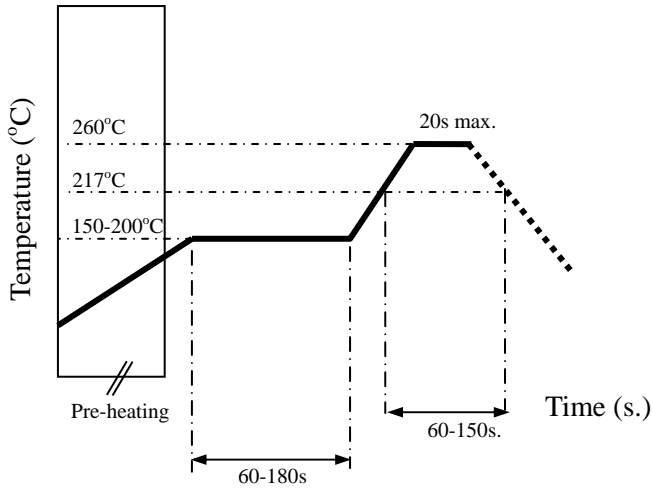

Notes

❖ The contents of this data sheet are subject to change without notice. Please confirm the specifications and delivery conditions when placing your order.

Advanced Ceramic X Corp.

16 Tzu Chiang Road, Hsinchu Industrial District Hsinchu Hsien 303, Taiwan

TEL:886-3-5987008 FAX:886-3-5987001

E-mail: acx@acxc.com.tw

<http://www.acxc.com.tw>