

DP 1608 Series

Multilayer Chip Diplexers

Features

- ❖ Monolithic structure including one low-pass and one band-pass filters with loss pole at adjacent passband.
- ❖ RoHS compliant.

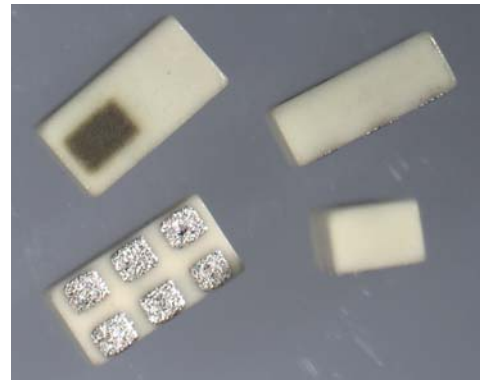

Applications

- ❖ Dual-band / dual-mode 2.4GHz/5-7GHz WLAN.

Specifications

Part Number	Passband (MHz)	Insertion Loss (dB)	VSWR	Attenuation (dB)	Isolation (dB)
DP1608-R2460NNQ2	2400~2500	0.8 max. / 0.6 typ. @ 25°C 1.0 max. / 0.8 typ. @ 105°C	2.0 max.	45 min. / 50 typ. @4800~5000MHz 15 min. / 33 typ. @7200~7500MHz	40 min. / 50 typ. @2400~2500MHz 40 min. / 50 typ. @4800~5000MHz
	4900~5100	1.3 max. / 1.0 typ. @ 25°C 1.5 max. / 1.2 typ. @ 105°C	2.0 max.	40 min. / 50 typ. @2400~2500MHz	40 min. / 45 typ. @5000~6000MHz
	5150~5950	1.0max. / 0.8 typ. @ 25°C 1.2max. / 1.0 typ. @ 105°C		22 min. / 25 typ. @10300~14300MHz	30 min. / 35 typ. @6000~7150MHz
	5950~7150	1.0max. / 0.8 typ. @ 25°C 1.2max. / 1.0 typ. @ 105°C		15 min. / 25 typ. @15300~21450MHz	

Q'ty/Reel (pcs) : 4000
 Operating Temperature Range : -40 ~ +105 °C
 Storage Temperature Range : -40 ~ +105 °C
 Storage Period : 12 months max.
 Power Capacity : 3W max.

Part Number

DP **1608** - **R** **2460** **NNQ2** **□** **/LF**
 ① ② ③ ④ ⑤ ⑥ ⑦

① Type	DP : Diplexer	② Dimensions (L x W)	1.6 x 0.8 mm
③ Material Code	R	④ Frequency Range	2460=2400MHz/6000MHz
⑤ Specification Code	NNQ2	⑥ Packaging	T: Tape & Reel B: Bulk
⑦ Soldering	/LF=lead-free		

Terminal Configuration

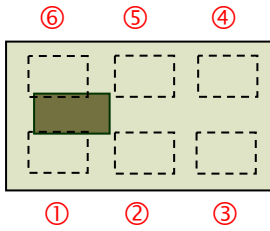

No.	Terminal Name	No.	Terminal Name
①	GND	④	Higher Freq. Port
②	Common Port	⑤	GND
③	GND	⑥	Lower Freq. Port

Dimensions

Unit : mm

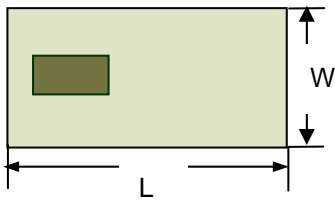

<Top View>

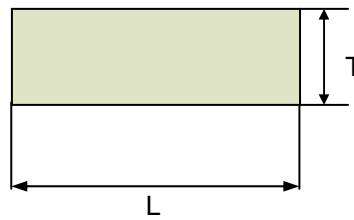

<Side View>

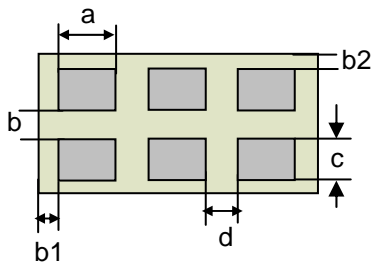

<Bottom View>

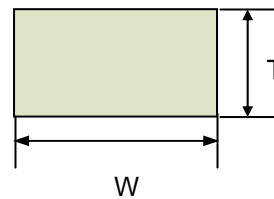

<Side View>

Mark	L	W	T	a	b	c	d	b1	b2
Dimensions	1.6±0.1	0.8±0.1	0.7 max.	0.3 ±0.1	0.2 ±0.1	0.25 ±0.1	0.2 ±0.1	0.15 ±0.05	0.05 ±0.05

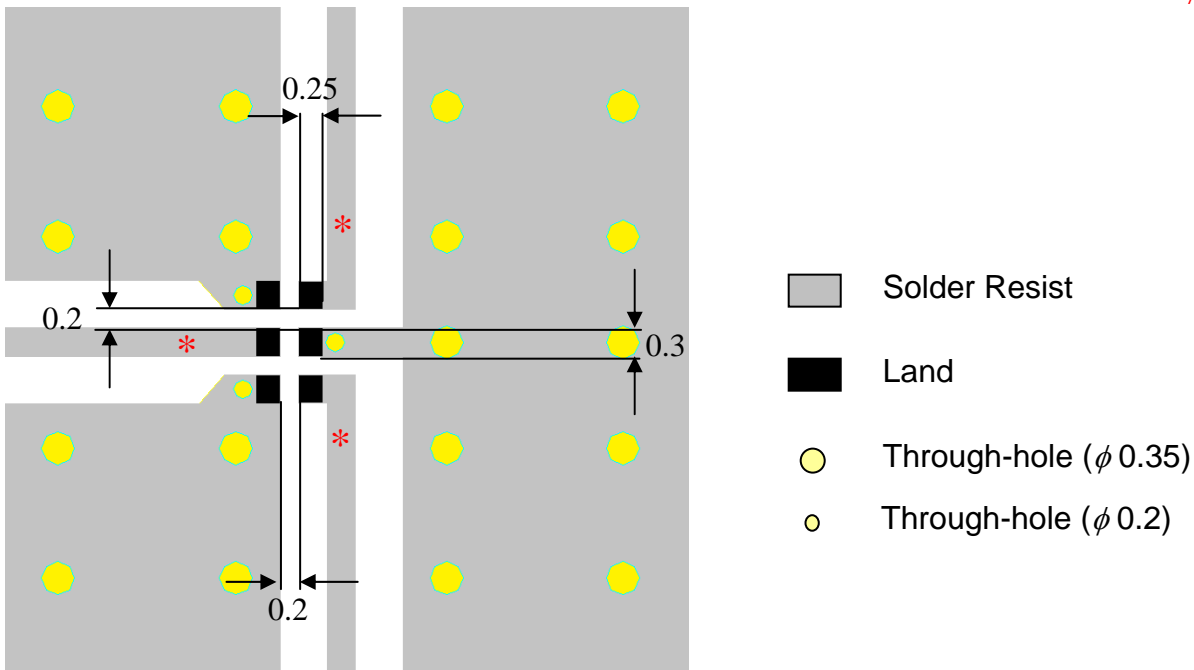

* Line width should be designed to match 50ohm characteristic impedance, depending on PCB material and thickness.

Measuring Diagram

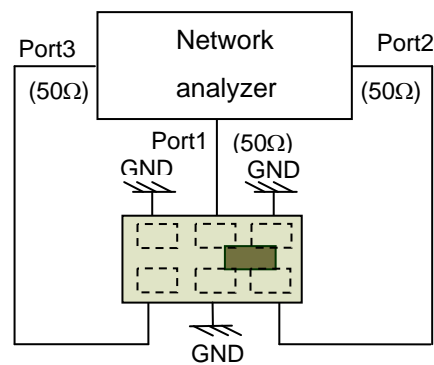

Typical Electrical Characteristics (T=25°C)

Attenuation

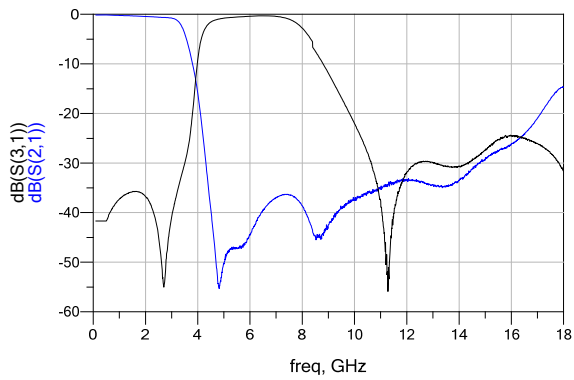

Return Loss

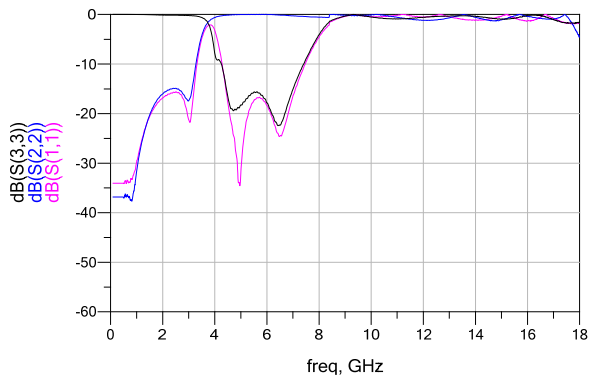

Isolation

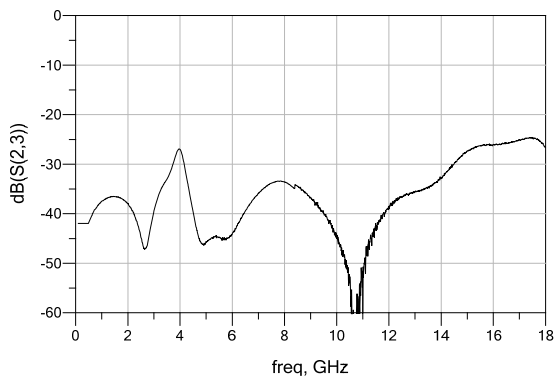

Notes

- ❖ The contents of this data sheet are subject to change without notice. Please confirm the specifications and delivery conditions when placing your order.

Taping Specifications

❖Tape Dimensions (Unit: mm) & Quantity

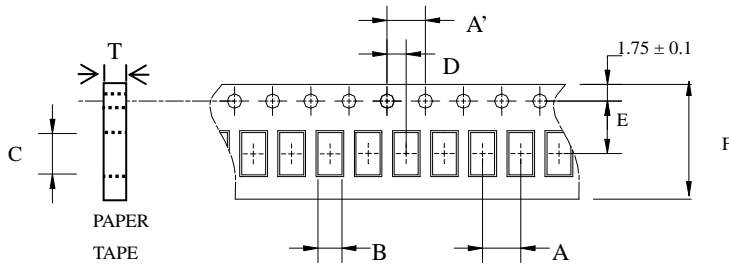

Type	A	A'	B	C	D	E	F	T	Quantity/reel	Tape material
1608	4.0±	4.0±	1.10±	1.92±	2.0±	3.5±	8.0±	0.75±	4,000pcs	Paper
	0.1	0.1	0.1	0.1	0.1	0.1	0.1	0.05		

❖Reel Dimensions (Unit: mm)

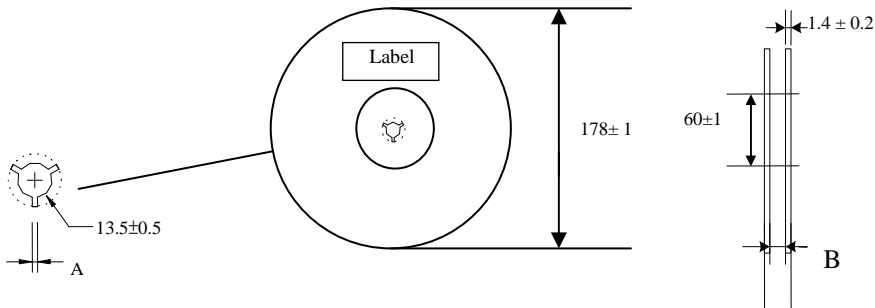

Label: Customer's Name,
ACX P/N, Q'ty, Date,
ACX Corp.

Type	A	B
1608	2.3±0.5	9.0±0.3

❖Leader and Trailer Tape

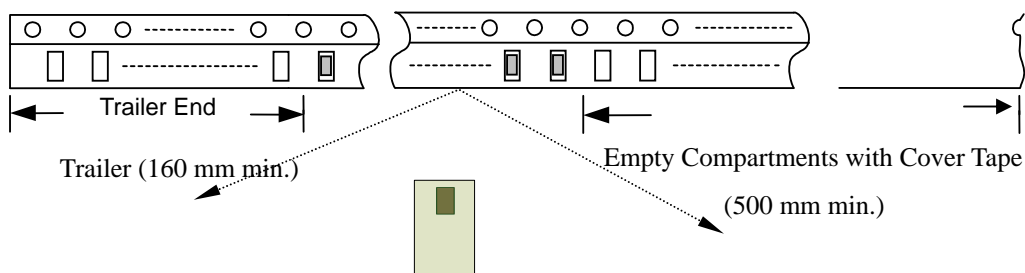

❖ **Peel-off Force**

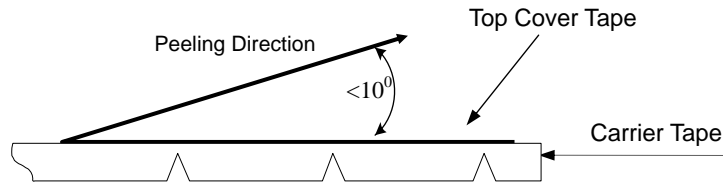

Peel-off force should be in the range of 0.1 – 0.6 N at a peel-off speed of 300 ± 10 mm/min .

❖ **Storage Conditions**

- (1) Temperature: 5 ~35°C , relative humidity (RH): 45~75%.
- (2) Non-corrosive environment.

Notes

- ❖ The contents of this data sheet are subject to change without notice. Please confirm the specifications and delivery conditions when placing your order.

Mechanical & Environmental Characteristics

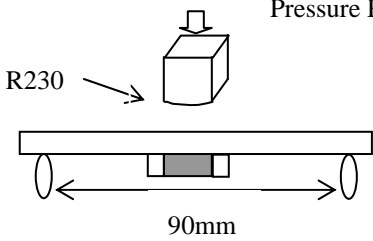
Item	Requirements	Procedure
Solderability	<ol style="list-style-type: none"> No apparent damage More than 95% of the terminal electrode shall be covered with new solder 	<ol style="list-style-type: none"> Preheat: $120 \pm 5^\circ\text{C}$ Solder: $245 \pm 5^\circ\text{C}$ for 5 ± 1 sec
Soldering strength (Termination Adhesion)	<ol style="list-style-type: none"> 10N minimum 	<ol style="list-style-type: none"> Solder specimen onto test jig. Apply push force at 0.5mm/s until electrode pads are peeled off or ceramic are broken. Pushing force is applied to longitude direction
Deflection (Substrate Bending)	<ol style="list-style-type: none"> No apparent damage 	<ol style="list-style-type: none"> Solder specimen onto test jig (FR4, 1.6mm) using the recommend soldering profile. Apply a bending force of 2mm deflection. 
Heat/Humidity Resistance	<ol style="list-style-type: none"> No apparent damage Fulfill the electrical specification after test 	<ol style="list-style-type: none"> Temperature: $85 \pm 2^\circ\text{C}$ Humidity: 90% ~ 95% RH Duration: 1000 ± 48hrs Recovery: 1-2hrs
Thermal shock (Temperature Cycle)	<ol style="list-style-type: none"> No apparent damage Fulfill the electrical specification after test 	<ol style="list-style-type: none"> One cycle/step 1 : $125 \pm 5^\circ\text{C}$ for 30 min step 2 : $-40 \pm 5^\circ\text{C}$ for 30 min No of cycles : 100 Recovery: 1-2 hrs
Low Temperature Resistance	<ol style="list-style-type: none"> No apparent damage Fulfill the electrical specification after test 	<ol style="list-style-type: none"> Temperature: $-40 \pm 5^\circ\text{C}$ Duration: 500 ± 24hrs Recovery: 1-2hrs

Soldering Conditions

❖ Typical Soldering Profile for Lead-free Process

Reflow Soldering :

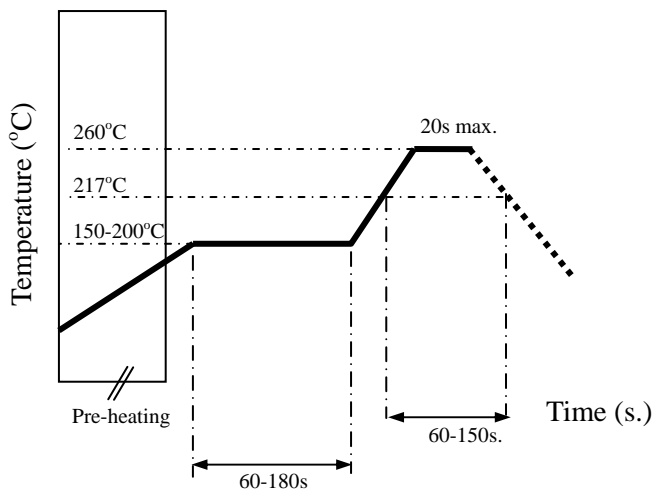

Notes

- ❖ The contents of this data sheet are subject to change without notice. Please confirm the specifications and delivery conditions when placing your order.

Advanced Ceramic X Corp.

16 Tzu Chiang Road, Hsinchu Industrial District Hsinchu Hsien 303, Taiwan

TEL:886-3-5987008 FAX:886-3-5987001

E-mail: acx@acxc.com.tw

<http://www.acxc.com.tw>