

BL 2012 Series

Multilayer Chip Baluns

Features

- ❖ Monolithic SMD with small, low-profile and light-weight type.
- ❖ RoHS compliant

Applications

- ❖ 0.8 ~ 6 GHz wireless communication systems, including DECT/PACS/PHS/GSM/DCS phones, WLAN card, Bluetooth modules, etc.

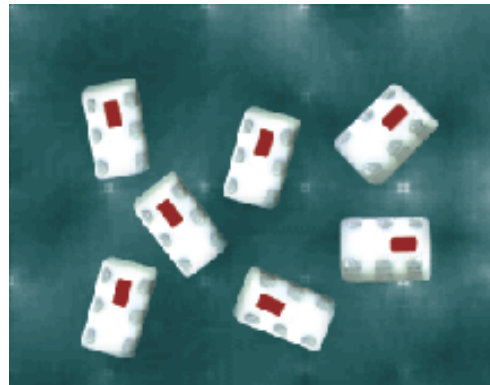

Specifications

Part Number	Frequency Range (MHz)	Unbalanced Impedance (ohm)	Balanced Impedance (ohm)	Insertion Loss (dB)	VSWR @BW	Phase Difference (degree)	Amplitude Difference (dB)
BL2012-05B1850_	1700 ~ 2000	50	50	1.0 max.	2 max.	180 ± 10	2 max.

Q'ty/Reel (pcs) : 4000
 Operating Temperature Range : -40 ~ +85 °C
 Storage Temperature Range : -40 ~ +85 °C
 Storage Period : 12 months max.
 Power Capacity : 3W max.

Part Number

BL 2012 - 05 B 1850 □ /LF
 ① ② ③ ④ ⑤ ⑥ ⑦

① Type	BL : Balun	② Dimensions (L x W)	2.0 x 1.25 mm
③ Balanced Impedance	05 : 50 ohm	④ Specification Code	B
⑤ Central Frequency	1850 : 1850MHz	⑥ Packaging	T: Tape & Reel B: Bulk
⑦ Soldering	/LF=lead-free		

Terminal Configuration

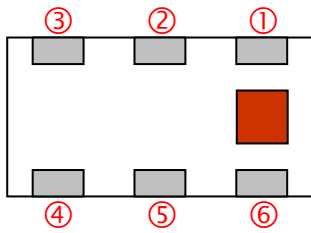

No.	Terminal Name	No.	Terminal Name
①	Unbalanced Port (IN)	④	Balanced Port (OUT2)
②	GND or DC feed + RF GND	⑤	GND
③	Balanced Port (OUT1)	⑥	NC

Dimensions and Recommended PC Board Pattern

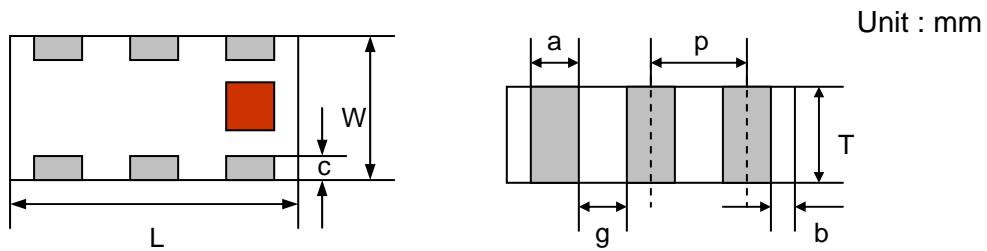

Mark	L	W	T	a	b	c	g	p
Dimensions	2.0 ± 0.1	1.25 ± 0.1	0.95 ± 0.1	0.3 ± 0.1	0.2 ± 0.1	0.3+0.1 / -0.2	0.35 ± 0.1	0.65 ± 0.05

Without DC feed

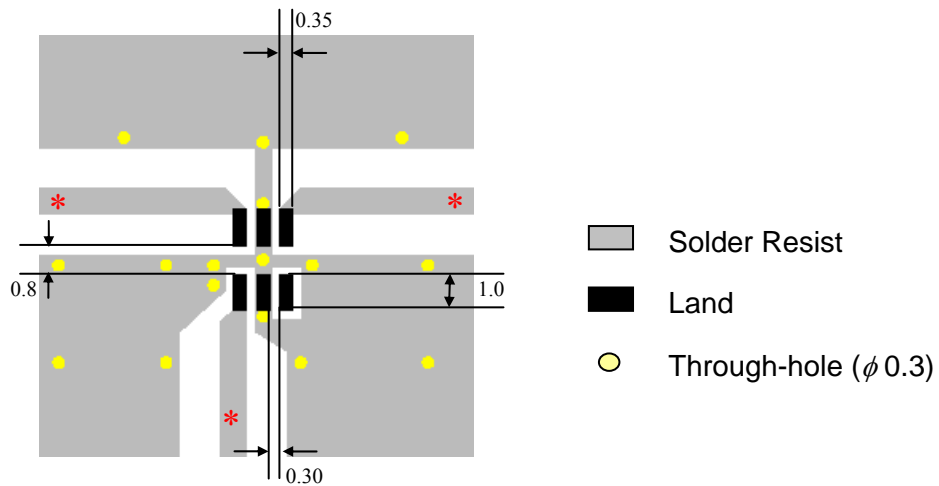

With DC feed

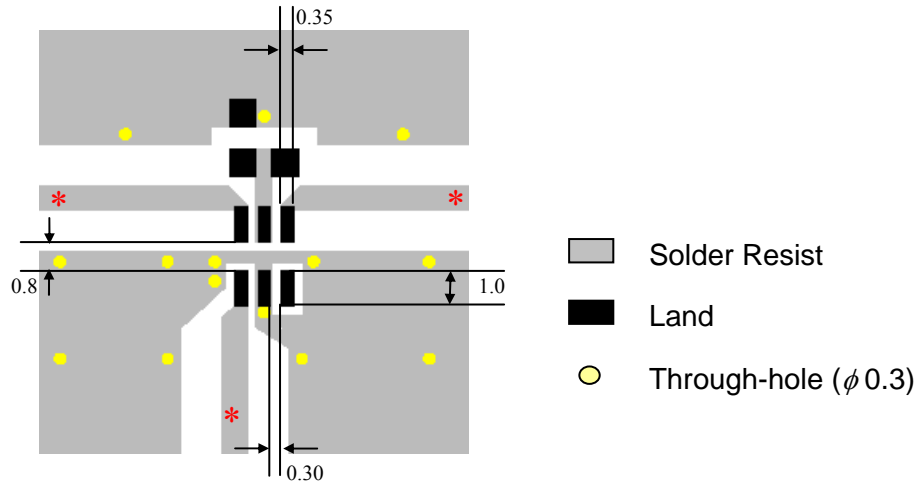

* Line width should be designed to match 50Ω characteristic impedance, depending on PCB material and thickness.

** By-pass capacitor should be connected when feeding DC power.

Equivalent Circuit

Unbalanced Port

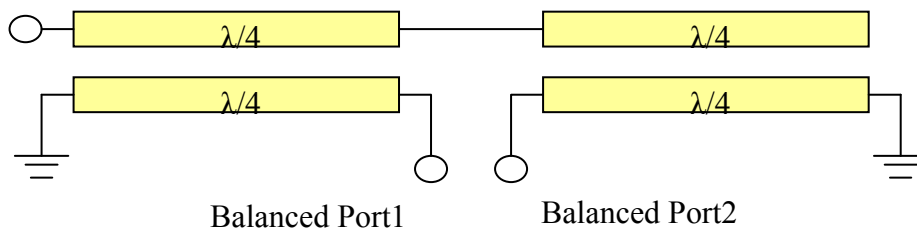

Measuring Diagram

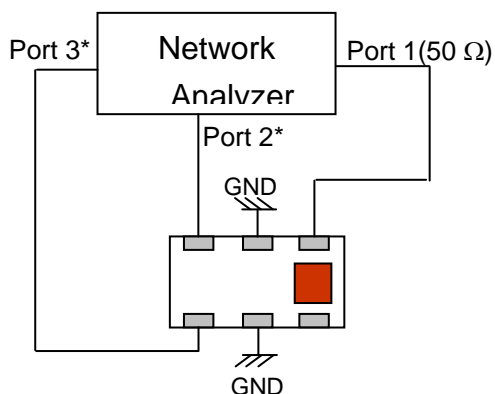

Port 1: Unbalanced Port

Ports 2 and 3: Balanced Port

$$IL = S_{ds21}$$

$$RL = S_{ss11}$$

$$\text{Amp_balance} = \text{dB}(S(2,1)/S(3,1))$$

$$\text{Phase_balance} = \text{Phase}(S(2,1)/S(3,1))$$

*Impedance for ports 2 and 3 = Balanced Impedance/2

Typical Electrical Characteristics (T=25°C)

Insertion and Return Loss

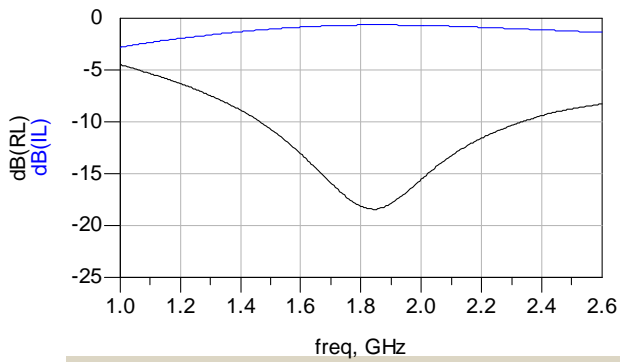

Amplitude and Phase Balance

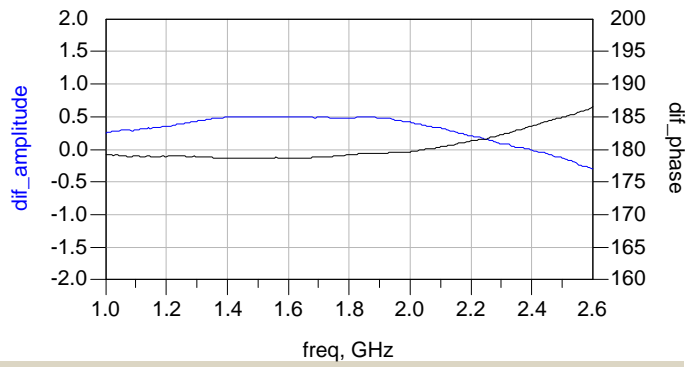

Notes

❖ The contents of this data sheet are subject to change without notice. Please confirm the specifications and delivery conditions when placing your order.

Taping Specifications

❖Tape Dimensions (Unit: mm) & Quantity

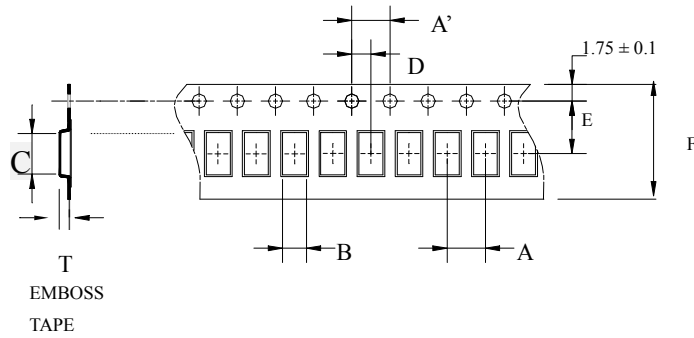

Type	A	A'	B	C	D	E	F	T	Quantity/reel	Tape material
2012	4.0± 0.1	4.0± 0.1	1.35± 0.05	2.15± 0.05	2.0± 0.05	3.5± 0.1	8.0± 0.1	1.08± 0.05	4,000pcs	Plastic (Embossed)

❖Reel Dimensions (Unit: mm)

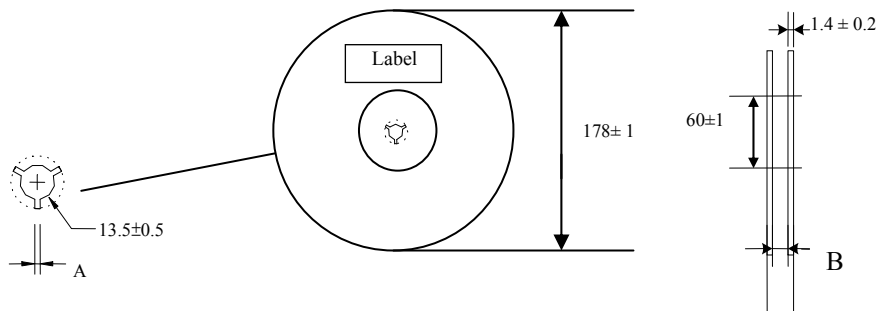

Type	A	B
2012	2.3±0.5	9.0±0.3

❖Leader and Trailer Tape

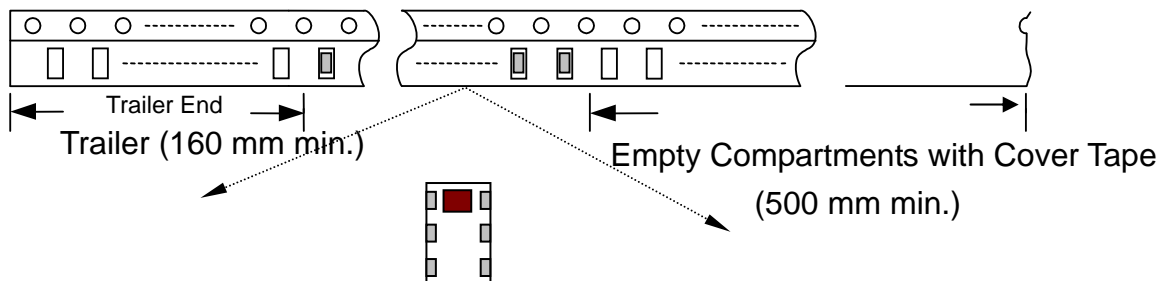

❖ **Peel-off Force**

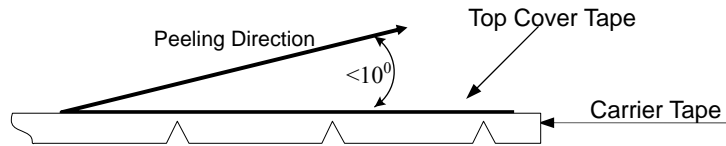

Peel-off force should be in the range of 0.1 – 0.6 N at a peel-off speed of 300 ± 10 mm/min .

❖ **Storage Conditions**

- (1) Temperature: $+5 \sim 35^{\circ}\text{C}$, relative humidity (RH): 45~75%.
- (2) Non-corrosive environment

Notes

- ❖ The contents of this data sheet are subject to change without notice. Please confirm the specifications and delivery conditions when placing your order.

Mechanical & Environmental Characteristics

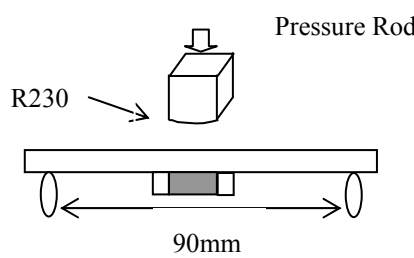
Item	Requirements	Procedure
Solderability	<ol style="list-style-type: none"> No apparent damage More than 95% of the terminal electrode shall be covered with new solder 	<ol style="list-style-type: none"> Preheat: $120 \pm 5^\circ\text{C}$ Solder: $245 \pm 5^\circ\text{C}$ for 5 ± 1 sec
Soldering strength (Termination Adhesion)	<ol style="list-style-type: none"> 1kg minimum 	<ol style="list-style-type: none"> Solder specimen onto test jig. Apply push force at 0.5mm/s until electrode pads are peeled off or ceramic are broken. Pushing force is applied to longitude direction
Deflection (Substrate Bending)	<ol style="list-style-type: none"> No apparent damage 	<ol style="list-style-type: none"> Solder specimen onto test jig (FR4, 0.8mm) using the recommend soldering profile. Apply a bending force of 2mm deflection 
Heat/Humidity Resistance	<ol style="list-style-type: none"> No apparent damage Fulfill the electrical specification after test 	<ol style="list-style-type: none"> Temperature: $85 \pm 2^\circ\text{C}$ Humidity: 90% ~ 95% RH Duration: 1000 ± 48hrs Recovery: 1-2hrs
Thermal shock (Temperature Cycle)	<ol style="list-style-type: none"> No apparent damage Fulfill the electrical specification after test 	<ol style="list-style-type: none"> One cycle/step 1 : $125 \pm 5^\circ\text{C}$ for 30 min step 2 : $-40 \pm 5^\circ\text{C}$ for 30 min No of cycles : 100 Recovery: 1-2 hrs
Low Temperature Resistance	<ol style="list-style-type: none"> No apparent damage Fulfill the electrical specification after test 	<ol style="list-style-type: none"> Temperature: $-40 \pm 5^\circ\text{C}$ Duration: 500 ± 24hrs Recovery: 1-2hrs

Soldering Conditions

❖ Typical Soldering Profile for Lead-free Process

Reflow Soldering :

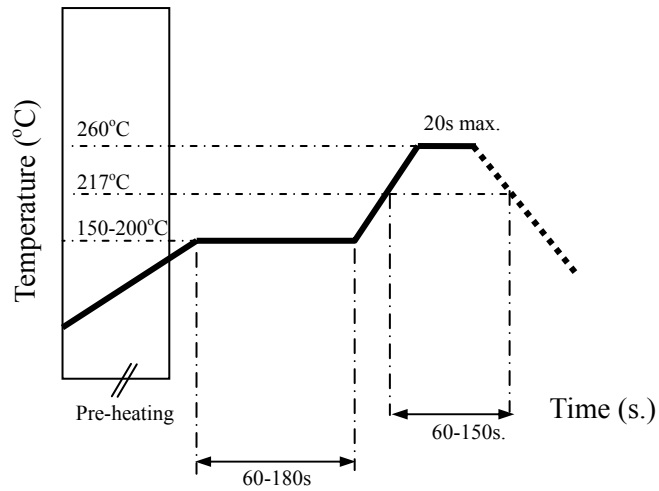

Notes

❖ The contents of this data sheet are subject to change without notice. Please confirm the specifications and delivery conditions when placing your order.

Advanced Ceramic X Corp.

16 Tzu Chiang Road, Hsinchu Industrial District Hsinchu Hsien 303, Taiwan

TEL:886-3-5987008 FAX:886-3-5987001

E-mail: acx@acxc.com.tw

<http://www.acxc.com.tw>