

# BL 1608 Series

## Multilayer Chip Baluns

### Features

- ❖ Monolithic SMD with small, low-profile and light-weight type.
- ❖ RoHS compliant.

### Applications

- ❖ 0.8 ~ 6 GHz wireless communication systems, including DECT/PACS/PHS/GSM/DCS phones, WLAN card, Bluetooth modules, Hyper-LAN, etc.



### Specifications

Part Number	Frequency Range (MHz)	Unbalanced Impedance (ohm)	Balanced Impedance (ohm)	Insertion Loss (dB)	VSWR @BW	Phase Difference (degree)	Amplitude Difference (dB)
<b>BL1608-05K2450_</b>	2400 ~2500	50	50	1.2 max. @ 25°C 1.4 max.@-40~105°C	2.0 max.	180 ± 10	2 max.

Q'ty/Reel (pcs) : 4000  
 Operating Temperature Range : -40 ~ +105 °C  
 Storage Temperature Range : -40 ~ +105 °C  
 Storage Period : 12 months max.  
 Power Capacity : 3W max.

### Part Number

**BL**   **1608**   -   **05**   **K**   **2450**   **□**   **/LF**  
 ①   ②   ③   ④   ⑤   ⑥   ⑦

① Type	BL : Balun	② Dimensions ( L × W )	1.6 × 0.8 mm
③ Balanced Impedance	05 : 50 ohm	④ Specification Code	K
⑤ Central Frequency	2450 : 2450MHz	⑥ Packaging	T: Tape & Reel B: Bulk
⑦ Soldering	/LF=lead-free		

### Terminal Configuration

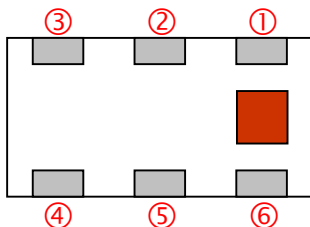

No.	Terminal Name	No.	Terminal Name
①	Unbalanced Port (IN)	④	Balanced Port (OUT2)
②	GND or DC feed + RF GND	⑤	GND
③	Balanced Port (OUT1)	⑥	NC

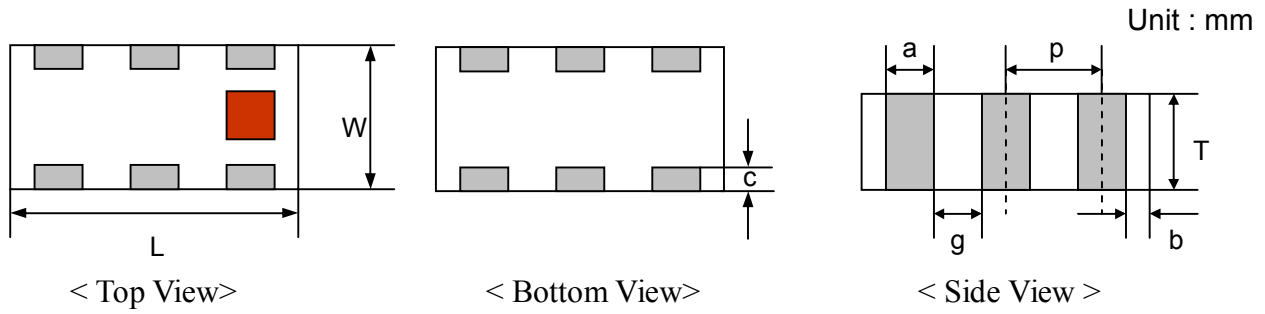

## Dimensions and Recommended PC Board Pattern



Mark	L	W	T	a	b	c	g	p
Dimensions	$1.6 \pm 0.1$	$0.8 \pm 0.1$	$0.6 \pm 0.1$	$0.2 \pm 0.1$	$0.2+0.1$ $-0.15$	$0.15 \pm 0.1$	$0.3 \pm 0.1$	$0.50 \pm 0.05$

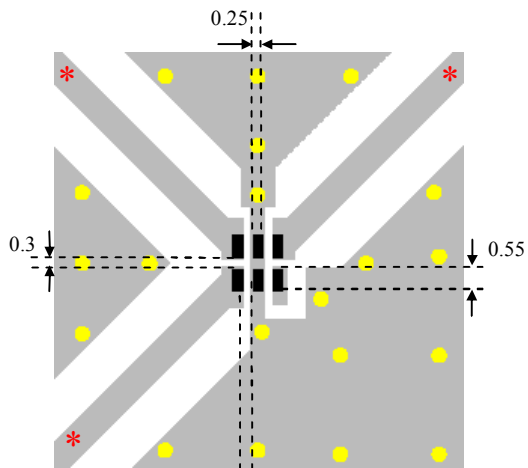

### Without DC feed

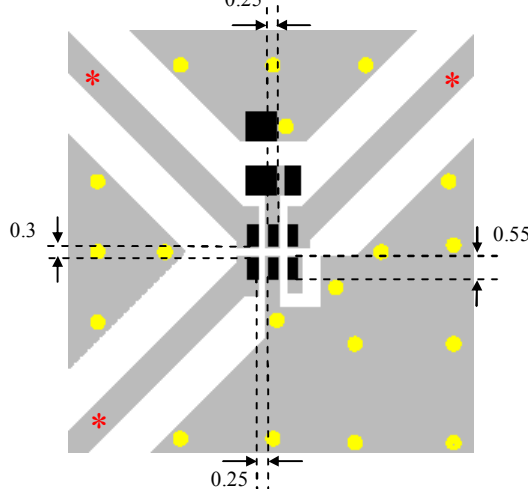

-  Solder Resist
-  Land
-  Through-hole ( $\phi 0.3$ )

### With DC feed



-  Solder Resist
-  Land
-  Through-hole ( $\phi 0.3$ )

\* Line width should be designed to match  $50\Omega$  characteristic impedance, depending on PCB material and thickness.

\*\* By-pass capacitor should be connected when feeding DC power.

## Equivalent Circuit

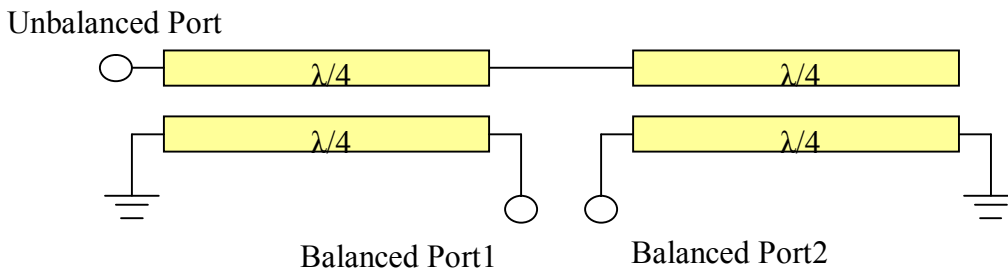

## Measuring Diagram

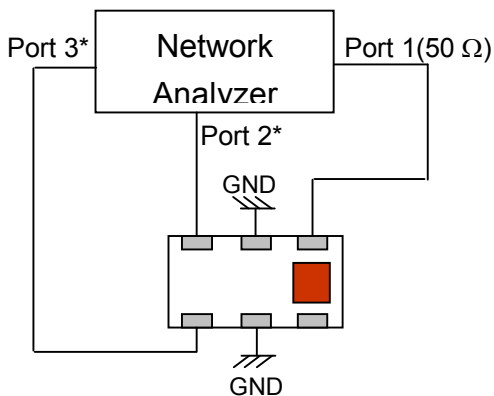

Port 1: Unbalanced Port

Ports 2 and 3: Balanced Port

$$IL = S_{ds21}$$

$$RL = S_{ss11}$$

$$\text{Amp\_balance} = \text{dB}(S(2,1)/S(3,1))$$

$$\text{Phase\_balance} = \text{Phase}(S(2,1)/S(3,1))$$

\*Impedance for ports 2 and 3 = Balanced Impedance/2

## Typical Electrical Characteristics (T=25°C)

### Insertion and Return Loss

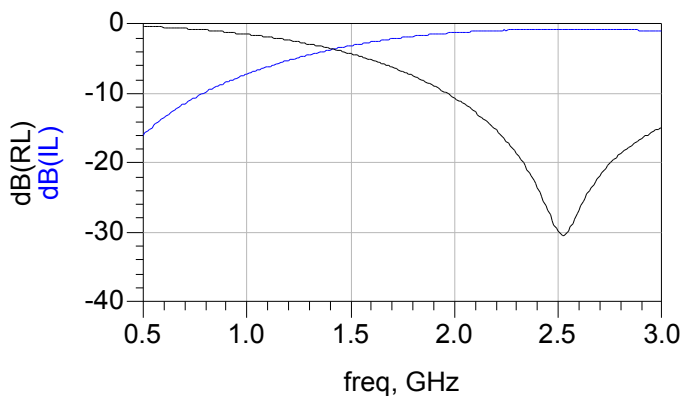

### Amplitude and Phase Balance

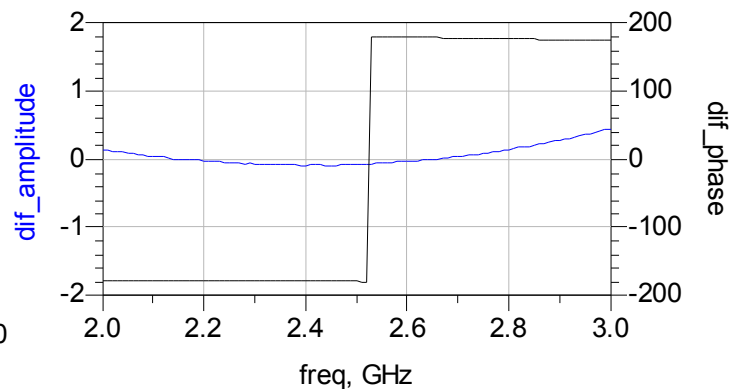

## Notes

❖ The contents of this data sheet are subject to change without notice. Please confirm the specifications and delivery conditions when placing your order.

## Taping Specifications

### ❖Tape Dimensions (Unit: mm) & Quantity

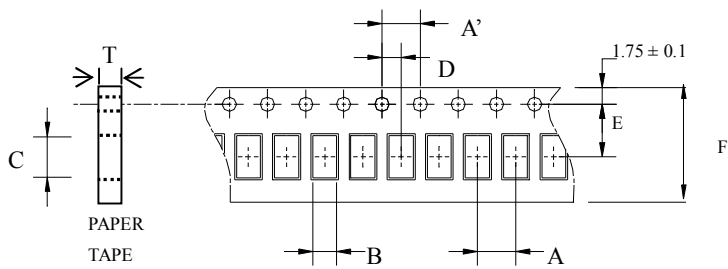

Type	A	A'	B	C	D	E	F	T	Quantity/reel	Tape material
1608	4.0±	4.0±	1.10±	1.92±	2.0±	3.5±	8.0±	0.75±	4,000pcs	Paper
	0.1	0.1	0.1	0.1	0.1	0.1	0.1	0.05		

### ❖Reel Dimensions (Unit: mm)

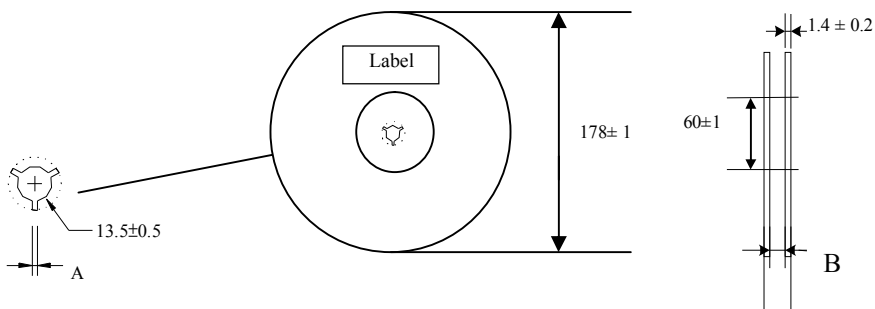

Label: Customer's Name,  
ACX P/N, Q'ty, Date,  
ACX Corp.

Type	A	B
1608	2.3±0.5	9.0±0.3

### ❖Leader and Trailer Tape (Plastic material)

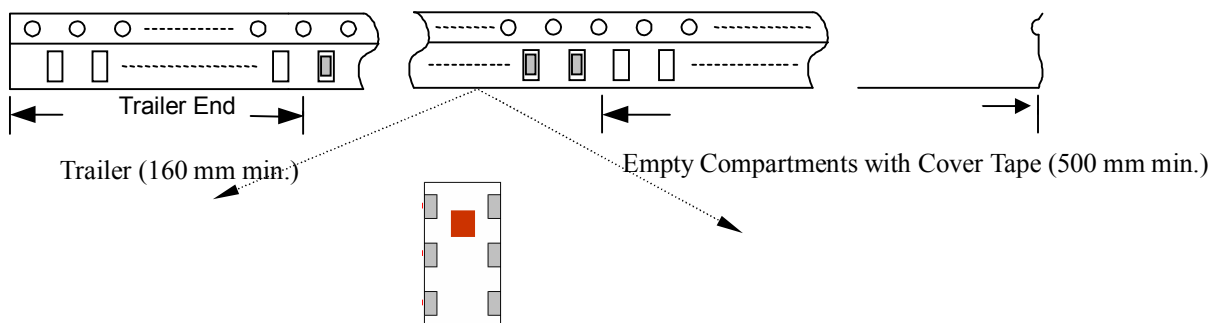

❖ **Peel-off Force**

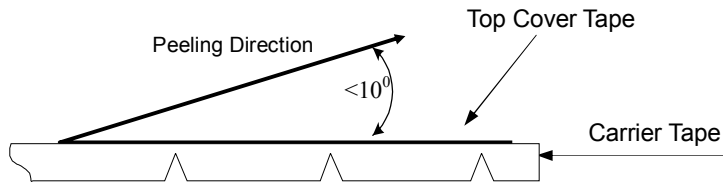

Peel-off force should be in the range of 0.1 – 0.6 N at a peel-off speed of  $300 \pm 10$  mm/min .

❖ **Storage Conditions**

- (1) Temperature: 5 ~35°C , relative humidity (RH): 45~75%.
- (2) Non-corrosive environment.

**Notes**

- ❖ The contents of this data sheet are subject to change without notice. Please confirm the specifications and delivery conditions when placing your order.

## Mechanical & Environmental Characteristics

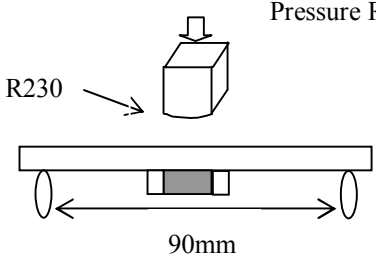
Item	Requirements	Procedure
Solderability	<ol style="list-style-type: none"> <li>No apparent damage</li> <li>More than 95% of the terminal electrode shall be covered with new solder</li> </ol>	<ol style="list-style-type: none"> <li>Preheat: <math>120 \pm 5^\circ\text{C}</math></li> <li>Solder: <math>245 \pm 5^\circ\text{C}</math> for <math>5 \pm 1</math> sec</li> </ol>
Soldering strength (Termination Adhesion)	<ol style="list-style-type: none"> <li>1kg minimum</li> </ol>	<ol style="list-style-type: none"> <li>Solder specimen onto test jig.</li> <li>Apply push force at 0.5mm/s until electrode pads are peeled off or ceramic are broken. Pushing force is applied to longitude direction</li> </ol>
Deflection (Substrate Bending)	<ol style="list-style-type: none"> <li>No apparent damage</li> </ol>	<ol style="list-style-type: none"> <li>Solder specimen onto test jig (FR4, 0.8mm) using the recommend soldering profile.</li> <li>Apply a bending force of 2mm deflection</li> </ol> 
Heat/Humidity Resistance	<ol style="list-style-type: none"> <li>No apparent damage</li> <li>Fulfill the electrical specification after test</li> </ol>	<ol style="list-style-type: none"> <li>Temperature: <math>85 \pm 2^\circ\text{C}</math></li> <li>Humidity: 90% ~ 95% RH</li> <li>Duration: <math>1000 \pm 48</math>hrs</li> <li>Recovery: 1-2hrs</li> </ol>
Thermal shock (Temperature Cycle)	<ol style="list-style-type: none"> <li>No apparent damage</li> <li>Fulfill the electrical specification after test</li> </ol>	<ol style="list-style-type: none"> <li>One cycle/step 1 : <math>125 \pm 5^\circ\text{C}</math> for 30 min step 2 : <math>-40 \pm 5^\circ\text{C}</math> for 30 min</li> <li>No of cycles : 100</li> <li>Recovery: 1-2 hrs</li> </ol>
Low Temperature Resistance	<ol style="list-style-type: none"> <li>No apparent damage</li> <li>Fulfill the electrical specification after test</li> </ol>	<ol style="list-style-type: none"> <li>Temperature: <math>-40 \pm 5^\circ\text{C}</math></li> <li>Duration: <math>500 \pm 24</math>hrs</li> <li>Recovery: 1-2hrs</li> </ol>

## Soldering Conditions

### ❖ Typical Soldering Profile for Lead-free Process

Reflow Soldering :

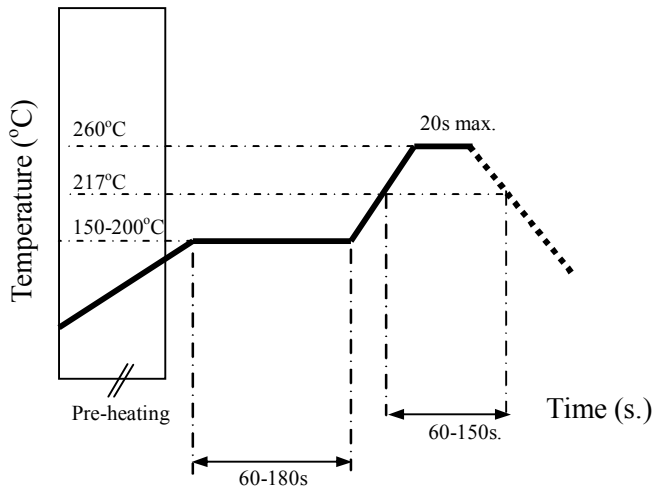

## Notes

- ❖ The contents of this data sheet are subject to change without notice. Please confirm the specifications and delivery conditions when placing your order.

### **Advanced Ceramic X Corp.**

16 Tzu Chiang Road, Hsinchu Industrial District Hsinchu Hsien 303, Taiwan

TEL:886-3-5987008 FAX:886-3-5987001

E-mail: [acx@acxc.com.tw](mailto:acx@acxc.com.tw) <http://www.acxc.com.tw>