

# BF 4532 Series

Multilayer Chip Band-Pass Filters

## Features

- ❖ Ultra small SMD type with low loss at pass-band and high attenuation at stop-band.
- ❖ RoHS compliant.

## Applications

- ❖ Wireless communication systems

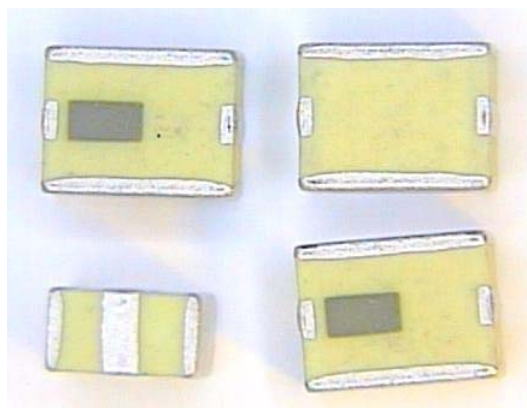

## Specifications

Part Number	Freq. Range (MHz)	Insertion Loss @ BW (dB)	Ripple @ BW any 80MHz (dB)	Return Loss @ BW (dB)	Frequency (MHz)	Attenuation (dB)
<b>BF4532-R5R4CAE_</b>	5170 ~5700	2.3 max.	1.5 max.	10 min.	DC ~ 2500	30 min.
					3400 ~ 3870	18 min.
	5700 ~5725	2.5 max.			5935 ~ 6425	40 min.
					10300 ~ 14450	15 min.

Q'ty/Reel (pcs) : 1000  
 Operating Temperature Range : -40 ~ +85 °C  
 Storage Temperature Range : -40 ~ +85 °C  
 Storage Period : 12 months max.  
 Power Capacity : 3W max.

## Part Number

**BF**   **4532**   -   **R**   **5R4**   **CAE**   **□**   **/LF**  
 ①   ②   ③   ④   ⑤   ⑥   ⑦

① Type	BF : Band-Pass Filter	② Dimensions ( L × W )	4.5 × 3.2 mm
③ Material Code	R	④ Frequency Range	5R4=5400MHz
⑤ Specification Code	CAE	⑥ Packaging	T: Tape & Reel B: Bulk
⑦ Soldering	/LF=lead-free		

## Terminal Configuration

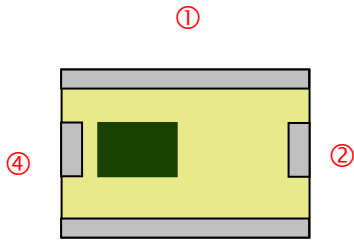

No.	Terminal Name	No.	Terminal Name
①	GND	③	GND
②	OUT/IN	④	IN/OUT

## Dimensions and Recommended PC Board Pattern

Unit : mm

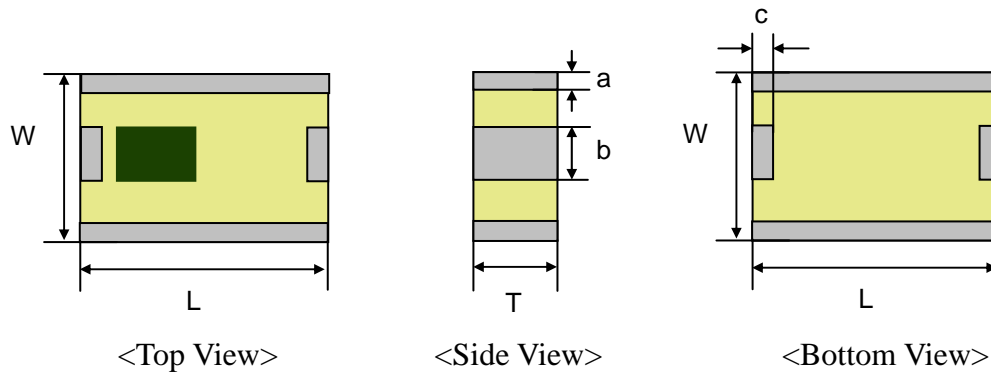

Mark	L	W	T	a	b	c
Dimensions	4.5 ±	3.2 ±	2.2	0.4 ±	0.8 ±	0.3 ±
	0.2	0.2	max.	0.2	0.2	0.15

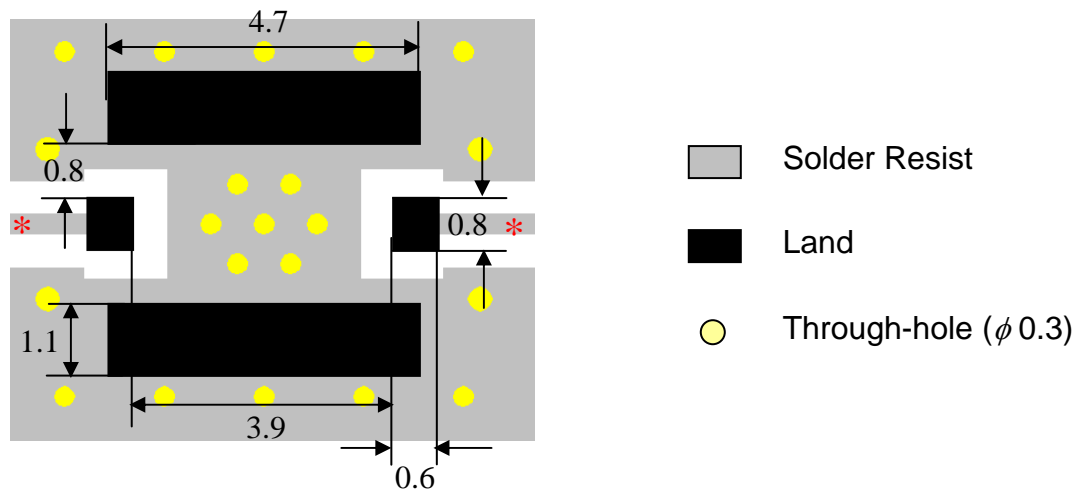

\* Line width should be designed to match 50Ω characteristic impedance, depending on PCB material and thickness.

## Measuring Diagram

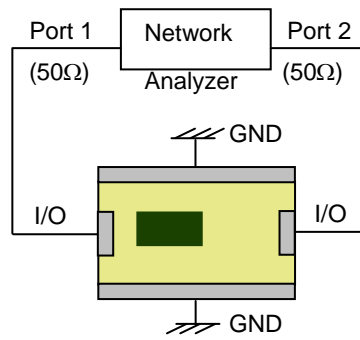

## Electrical Characteristics (T=25°C)

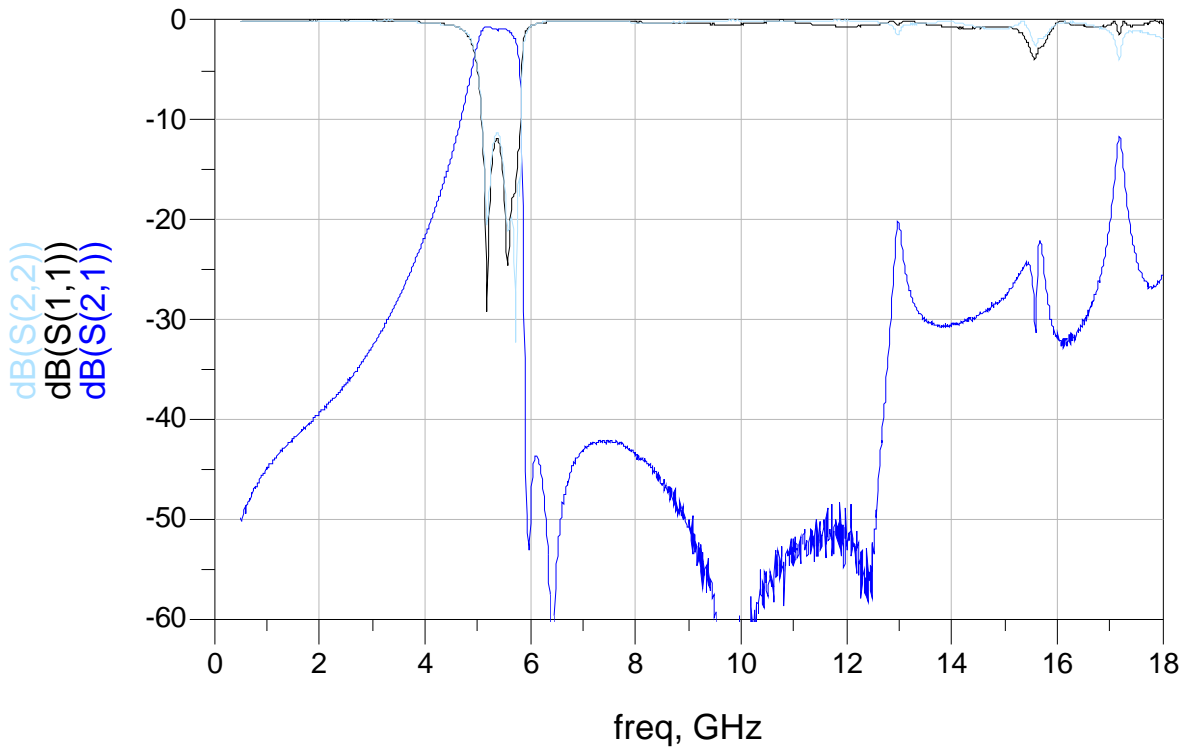

## Notes

- ❖ The contents of this data sheet are subject to change without notice. Please confirm the specifications and delivery conditions when placing your order.

## Taping Specifications

### ❖Tape & Reel Dimensions (Unit: mm)

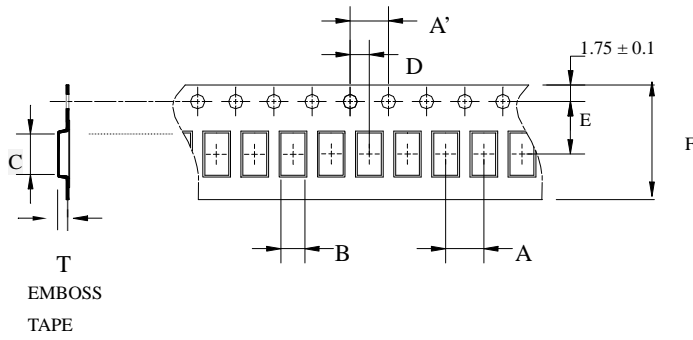

Type	A	A'	B	C	D	E	F	T	Quantity/per reel	Tape material
4532	8.0±	4.0±	3.50±	4.90±	2.0±	5.50±	12.0±	2.20±	1,000pcs	Plastic (Embossed)
	0.10	0.10	0.10	0.10	0.10	0.10	0.10	0.10		

### ❖Reel Dimensions (Unit: mm)

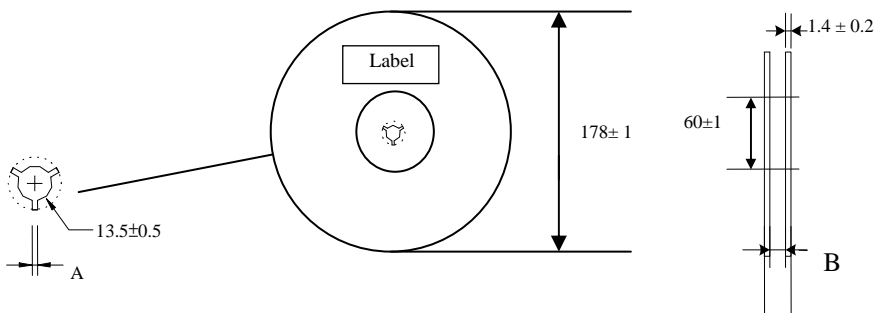

Label: Customer's Name,  
ACX P/N, Q'ty, Date,  
ACX Corp.

Type	A	B
4532	2.3±0.5	17.0±0.5

### ❖Leader and Trailer Tape

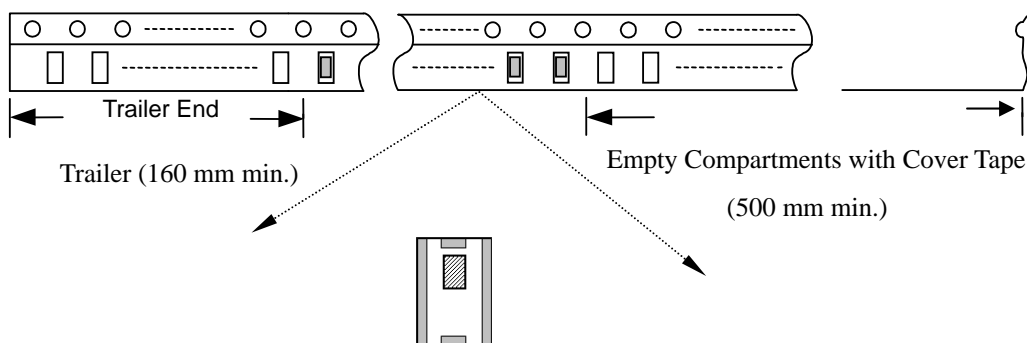

❖ **Peel-off Force**

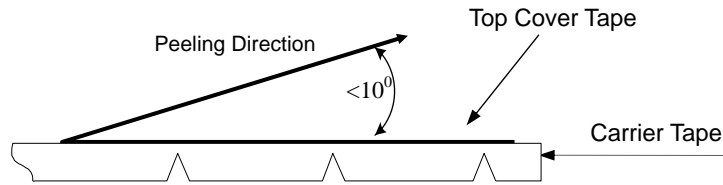

Peel-off force should be in the range of 0.1 – 0.6 N at a peel-off speed of  $300 \pm 10$  mm/min .

❖ **Storage Conditions**

- (1) Temperature:  $5 \sim 35^{\circ}\text{C}$ , relative humidity (RH): 45~75%.
- (2) Non-corrosive environment

**Notes**

❖ The contents of this data sheet are subject to change without notice. Please confirm the specifications and delivery conditions when placing your order.

## Mechanical & Environmental Characteristics

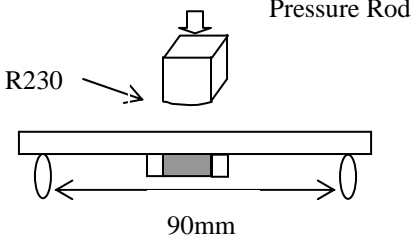
Item	Requirements	Procedure
Solderability	<ol style="list-style-type: none"> <li>No apparent damage</li> <li>More than 95% of the terminal electrode shall be covered with new solder</li> </ol>	<ol style="list-style-type: none"> <li>Preheat: <math>120 \pm 5^\circ\text{C}</math></li> <li>Solder: <math>245 \pm 5^\circ\text{C}</math> for <math>5 \pm 1</math> sec</li> </ol>
Soldering strength (Termination Adhesion)	<ol style="list-style-type: none"> <li>10N minimum</li> </ol>	<ol style="list-style-type: none"> <li>Solder specimen onto test jig.</li> <li>Apply push force at 0.5mm/s until electrode pads are peeled off or ceramic are broken. Pushing force is applied to longitude direction.</li> </ol>
Deflection (Substrate Bending)	<ol style="list-style-type: none"> <li>No apparent damage</li> </ol>	<ol style="list-style-type: none"> <li>Solder specimen onto test jig (FR4, 1.6mm) using the recommend soldering profile.</li> <li>Apply a bending force of 1 mm deflection</li> </ol> 
Heat/Humidity Resistance	<ol style="list-style-type: none"> <li>No apparent damage</li> <li>Fulfill the electrical specification after test</li> </ol>	<ol style="list-style-type: none"> <li>Temperature: <math>85 \pm 2^\circ\text{C}</math></li> <li>Humidity: 90% ~ 95% RH</li> <li>Duration: <math>1000 \pm 48</math>hrs</li> <li>Recovery: 1-2hrs</li> </ol>
Thermal shock (Temperature Cycle)	<ol style="list-style-type: none"> <li>No apparent damage</li> <li>Fulfill the electrical specification after test</li> </ol>	<ol style="list-style-type: none"> <li>One cycle/step 1 : <math>125 \pm 5^\circ\text{C}</math> for 30 min step 2 : <math>-40 \pm 5^\circ\text{C}</math> for 30 min</li> <li>No of cycles : 100</li> <li>Recovery: 1-2 hrs</li> </ol>
Low Temperature Resistance	<ol style="list-style-type: none"> <li>No apparent damage</li> <li>Fulfill the electrical specification after test</li> </ol>	<ol style="list-style-type: none"> <li>Temperature: <math>-40 \pm 5^\circ\text{C}</math></li> <li>Duration: <math>500 \pm 24</math>hrs</li> <li>Recovery: 1-2hrs</li> </ol>

## Soldering Conditions

### ❖ Typical Soldering Profile for Lead-free Process

Reflow Soldering :

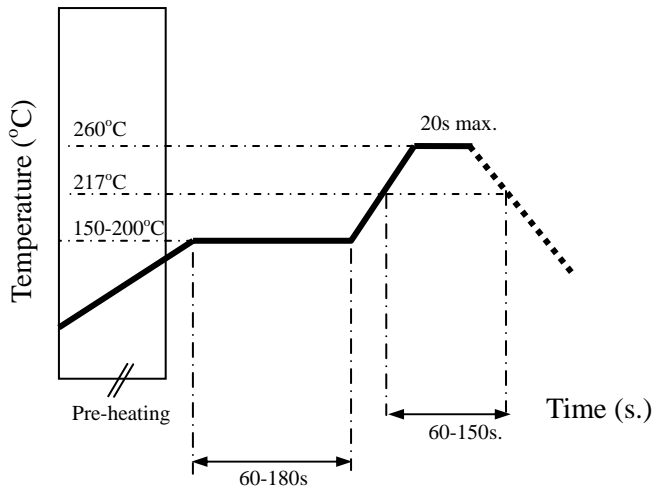

## Notes

❖ The contents of this data sheet are subject to change without notice. Please confirm the specifications and delivery conditions when placing your order.

### **Advanced Ceramic X Corp.**

16 Tzu Chiang Road, Hsinchu Industrial District Hsinchu Hsien 303, Taiwan

TEL:886-3-5987008 FAX:886-3-5987001

E-mail: [acx@acxc.com.tw](mailto:acx@acxc.com.tw)

<http://www.acxc.com.tw>