

# BF 3225 Series

Multilayer Chip Band-Pass Filters

## Features

- ❖ Ultra small SMD type with low loss at pass-band and high attenuation at stop-band.
- ❖ RoHS compliant

## Applications

- ❖ 5.49~5.835 GHz Wireless communication systems.

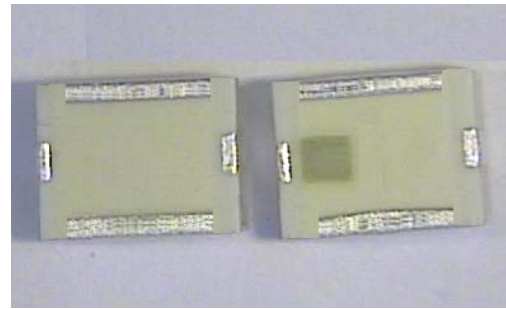

## Specifications

Part Number	Freq. Range (MHz)	Insertion Loss @ BW (dB)	VSWR @ BW	Ripple @ BW	Frequency	Attenuation (dB)
BF3225-R5R6DAQ_	5490 ~5835	2.5 max.	2.0 max.	2.1 max	2400 ~ 2500MHz	30 min.
					5150 ~ 5330MHz	25 min.
					5925 ~ 7125MHz	1.5 typ.
					10980 ~11700MHz	25 min.

Q'ty/Reel (pcs) : 2,000  
 Operating Temperature Range : -40 ~ +85 °C  
 Storage Temperature Range : -40 ~ +85 °C  
 Storage Period : 12 months max.  
 Power Capacity : 3W max.

## Part Number

BF   3225   -   R   5R6   DAQ   □   /LF  
 ①   ②   ③   ④   ⑤   ⑥   ⑦

① Type	BF : Band-Pass Filter	② Dimensions ( L x W )	3.2 x 2.5 mm
③ Material Code	R	④ Frequency Range	5R6=5600MHz
⑤ Specification Code	DAQ	⑥ Packaging	T: Tape & Reel B: Bulk
⑦ Soldering	/LF=lead-free		

## Terminal Configuration

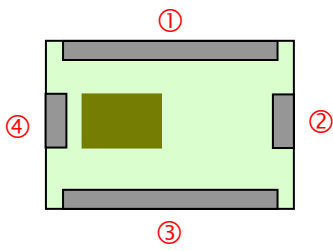

No.	Terminal Name	No.	Terminal Name
①	GND	③	GND
②	OUT/IN	④	IN/ OUT

## Dimensions and Recommended PC Board Pattern

Unit : mm

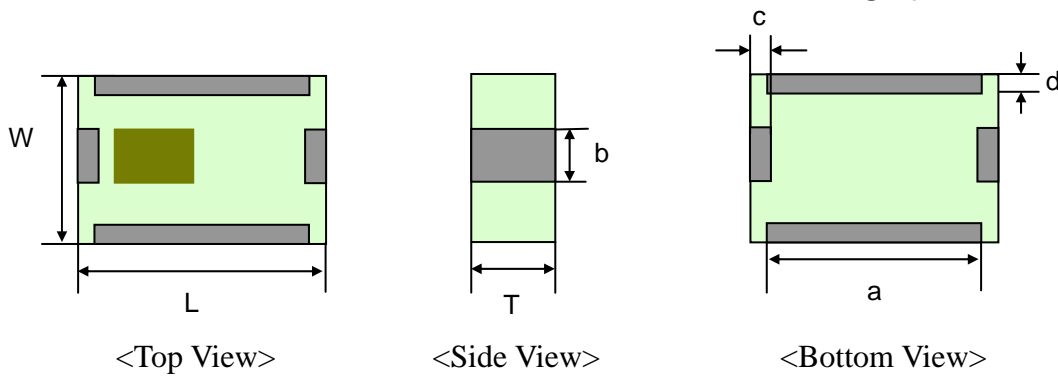

Mark	L	W	T	a	b	c	d
Dimensions	$3.2 \pm 0.2$	$2.5 \pm 0.2$	1.8 max.	$2.8 \pm 0.1$	$0.6 \pm 0.2$	$0.3 \pm 0.15$	$0.3 \pm 0.1$

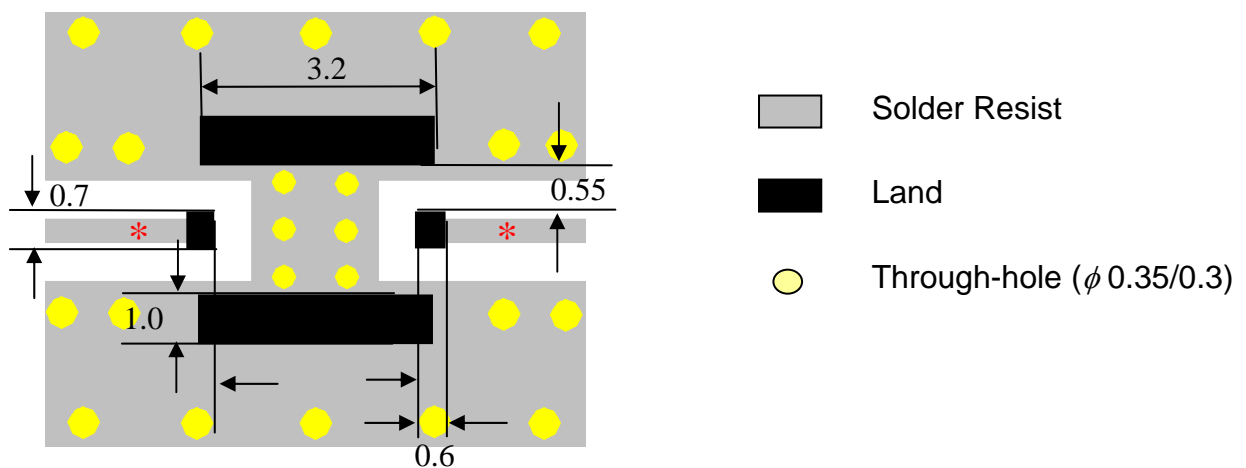

\* Line width should be designed to match 50  $\Omega$  characteristic impedance, depending on PCB material and thickness.

## Measuring Diagram

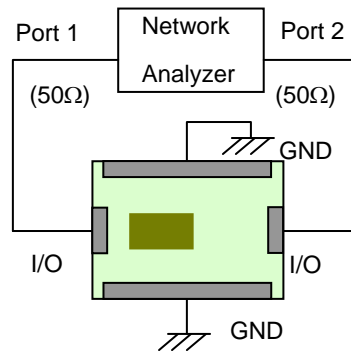

## Electrical Characteristics (T=25°C)

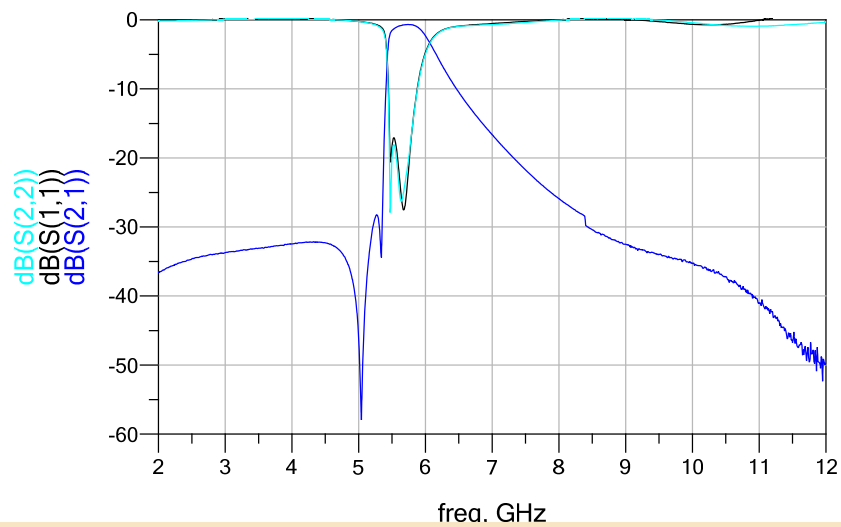

## Notes

- ❖ The contents of this data sheet are subject to change without notice. Please confirm the specifications and delivery conditions when placing your order.

## Taping Specifications

### ❖Tape Dimensions (Unit: mm) & Quantity

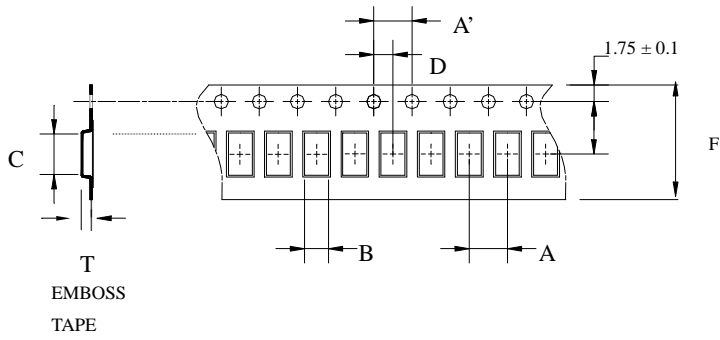

Type	A	A'	B	C	D	E	F	T	Quantity/reel	Tape material
3225	4.0±	4.0±	2.75±	3.45±	2.0±	3.5±	8.0±	1.70±	2,000pcs	Plastic (Embossed)
	0.1	0.1	0.1	0.1	0.1	0.1	0.1	0.10		

### ❖Reel Dimensions (Unit: mm)

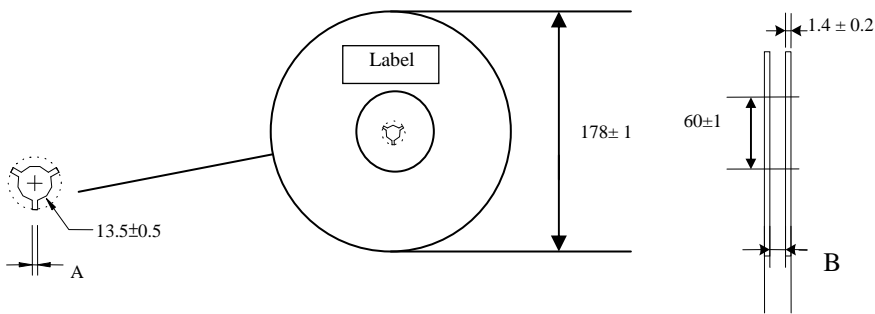

Label: Customer's Name,  
ACX P/N, Q'ty, Date,  
ACX Corp.

Type	A	B
3225	2.3±0.5	9.0±0.3

### ❖Leader and Trailer Tape

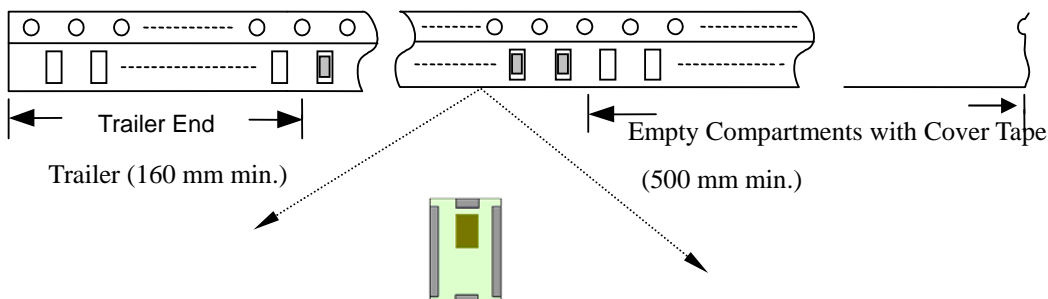

❖ **Peel-off Force**

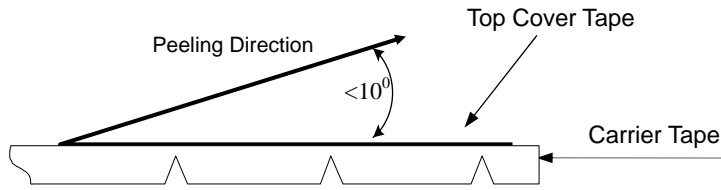

Peel-off force should be in the range of 0.1 – 0.6 N at a peel-off speed of  $300 \pm 10$  mm/min .

❖ **Storage Conditions**

- (1) Temperature: 5 ~35°C , relative humidity (RH): 45~75%.
- (2) Non-corrosive environment.

**Notes**

- ❖ The contents of this data sheet are subject to change without notice. Please confirm the specifications and delivery conditions when placing your order.

## Mechanical & Environmental Characteristics

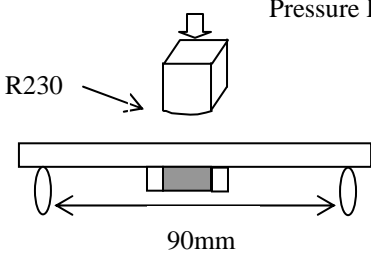
Item	Requirements	Procedure
Solderability	<ol style="list-style-type: none"> <li>No apparent damage</li> <li>More than 95% of the terminal electrode shall be covered with new solder</li> </ol>	<ol style="list-style-type: none"> <li>Preheat: <math>120 \pm 5^{\circ}\text{C}</math></li> <li>Solder: <math>245 \pm 5^{\circ}\text{C}</math> for <math>5 \pm 1</math> sec</li> </ol>
Soldering strength (Termination Adhesion)	<ol style="list-style-type: none"> <li>10N minimum</li> </ol>	<ol style="list-style-type: none"> <li>Solder specimen onto test jig.</li> <li>Apply push force at 0.5mm/s until electrode pads are peeled off or ceramic are broken. Pushing force is applied to longitude direction.</li> </ol>
Deflection (Substrate Bending)	<ol style="list-style-type: none"> <li>No apparent damage</li> </ol>	<ol style="list-style-type: none"> <li>Solder specimen onto test jig (FR4, 1.6mm) using the recommend soldering profile.</li> <li>Apply a bending force of 2mm deflection</li> </ol> 
Heat/Humidity Resistance	<ol style="list-style-type: none"> <li>No apparent damage</li> <li>Fulfill the electrical specification after test</li> </ol>	<ol style="list-style-type: none"> <li>Temperature: <math>85 \pm 2^{\circ}\text{C}</math></li> <li>Humidity: 90% ~ 95% RH</li> <li>Duration: <math>1000 \pm 48</math>hrs</li> <li>Recovery: 1-2hrs</li> </ol>
Thermal shock (Temperature Cycle)	<ol style="list-style-type: none"> <li>No apparent damage</li> <li>Fulfill the electrical specification after test</li> </ol>	<ol style="list-style-type: none"> <li>One cycle/step 1 : <math>125 \pm 5^{\circ}\text{C}</math> for 30 min step 2 : <math>-40 \pm 5^{\circ}\text{C}</math> for 30 min</li> <li>No of cycles : 100</li> <li>Recovery: 1-2 hrs</li> </ol>
Low Temperature Resistance	<ol style="list-style-type: none"> <li>No apparent damage</li> <li>Fulfill the electrical specification after test</li> </ol>	<ol style="list-style-type: none"> <li>Temperature: <math>-40 \pm 5^{\circ}\text{C}</math></li> <li>Duration: <math>500 \pm 24</math>hrs</li> <li>Recovery: 1-2hrs</li> </ol>

## Soldering Conditions

### ❖ Typical Soldering Profile for Lead-free Process

Reflow Soldering :

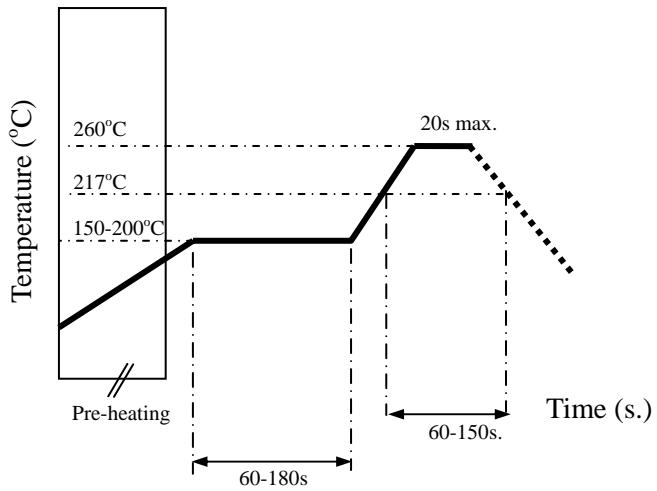

## Notes

❖ The contents of this data sheet are subject to change without notice. Please confirm the specifications and delivery conditions when placing your order.

### **Advanced Ceramic X Corp.**

16 Tzu Chiang Road, Hsinchu Industrial District Hsinchu Hsien 303, Taiwan

TEL:886-3-5987008 FAX:886-3-5987001

E-mail: [acx@acxc.com.tw](mailto:acx@acxc.com.tw)

<http://www.acxc.com.tw>