

BF 1608 Series

Multilayer Chip Band-Pass Filters

Features

- ❖ Ultra small SMD type with low loss at pass-band and high attenuation at stop-band.
- ❖ RoHS compliant.

Applications

- ❖ Mobile communication systems.

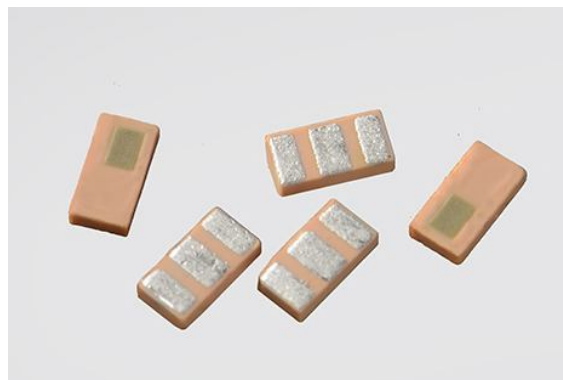

Specifications

Part Number	Freq.Range (MHz)	Insertion Loss @ BW(dB)	Return Loss @ BW(dB)	Frequency (MHz)	Attenuation (dB)
BF1608-L3R8NAC-P_	3300 ~ 4200	1.35 typ. / 1.7 max.	13 typ. / 10 min.	100 ~ 2570	47 typ. / 35 min.
				2170	49 typ. / 40 min.
				2620 ~ 2690	28 typ. / 25 min.
				5150 ~ 5950	26 typ. / 20 min.
				6600 ~ 8400	35 typ. / 27 min.
				9900 ~ 12600	33 typ. / 27 min.

Q'ty/Reel (pcs) : 4,000
 Operating Temperature Range : -40 ~ +105 °C
 Storage Temperature Range : -40 ~ +105 °C
 Storage Period : 12 months max.
 Power Capacity : 3W max.

Part Number

BF 1608 - L 3R8 NAC-P □ /LF
 ① ② ③ ④ ⑤ ⑥ ⑦

① Type	BF : Band-Pass Filter	② Dimensions (L × W)	1.6 × 0.8 mm
③ Material Code	L	④ Frequency Range	3R8=3800MHz
⑤ Specification Code	NAC-P	⑥ Packaging	T: Tape & Reel B: Bulk
⑦ Soldering	/LF=lead-free		

Terminal Configuration

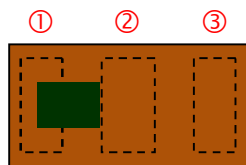

< Top View >

No.	Terminal Name	No.	Terminal Name
①	IN/OUT	③	IN/OUT
②	GND		

Dimensions and Recommended PC Board Pattern

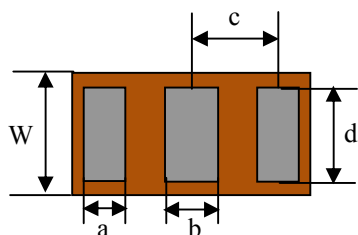

< Bottom View >

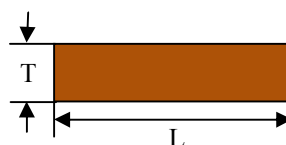

< Side View >

unit : mm

Mark	L	W	T	a	b	c	d
Dimensions	1.6 ±0.1	0.8 ±0.1	0.35 max.	0.3 ±0.1	0.4 ±0.1	0.6 ±0.1	0.7 ±0.1

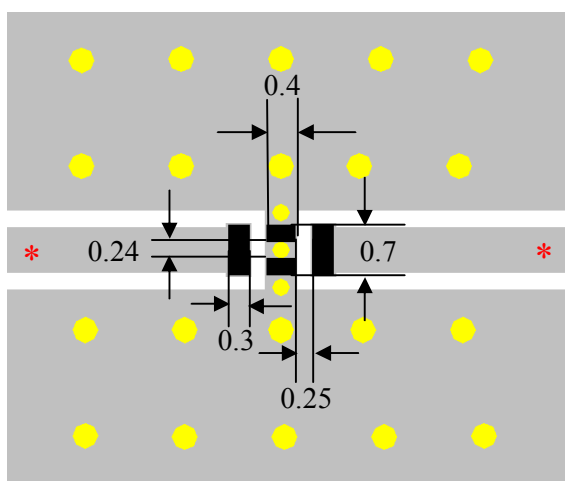

- Solder Resist
- Land
- Through-hole (ϕ 0.35, 0.23)

* Line width should be designed to match 50Ω characteristic impedance, depending on PCB material and thickness.

Measuring Diagram

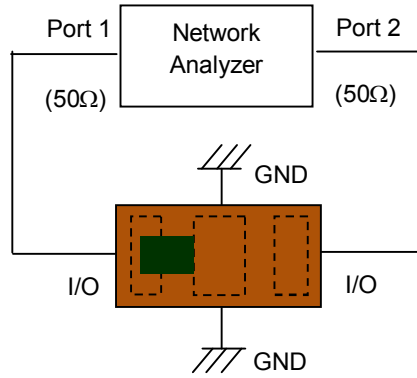

Electrical Characteristics (T=25°C)

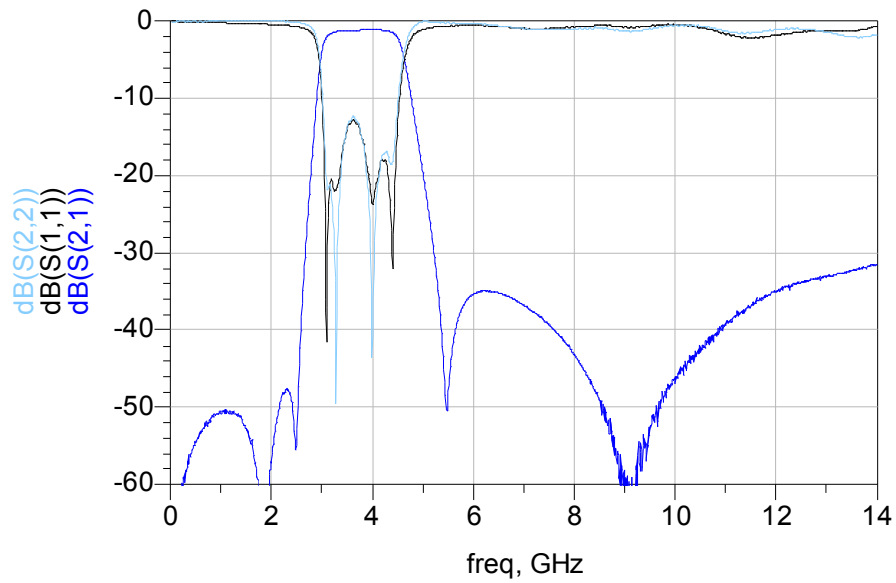

Notes

❖ The contents of this data sheet are subject to change without notice. Please confirm the specifications and delivery conditions when placing your order.

Taping Specifications

❖Tape Dimensions (Unit: mm) & Quantity

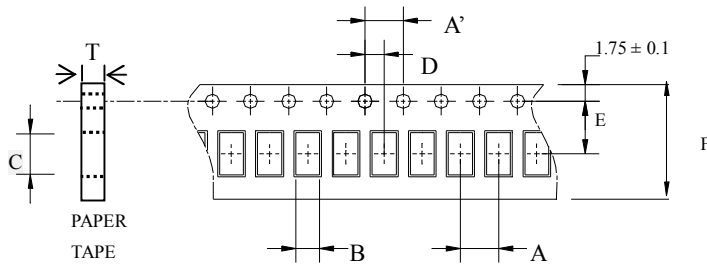

Type	A	A'	B	C	D	E	F	T	Quantity/reel	Tape material
1608	4.0±	4.0±	0.95±	1.80±	2.0±	3.5±	8.0±	0.60±	4,000pcs	Paper
	0.1	0.1	0.1	0.1	0.1	0.1	0.1	0.03		

❖Reel Dimensions (Unit: mm)

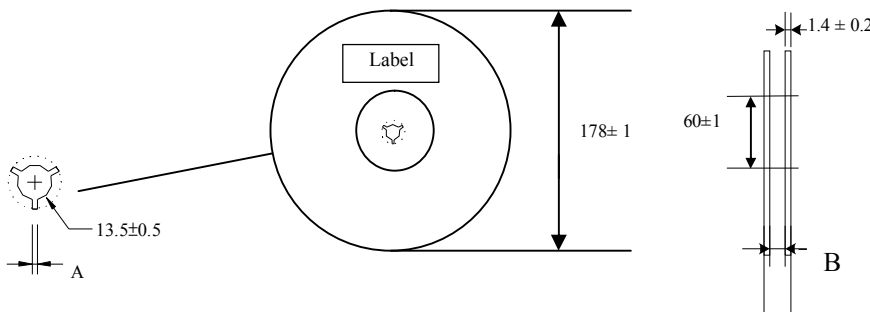

Label: Customer's Name,
ACX P/N, Q'ty, Date,
ACX Corp.

Type	A	B
1608	2.3±0.5	9.0±0.3

❖Leader and Trailer Tape

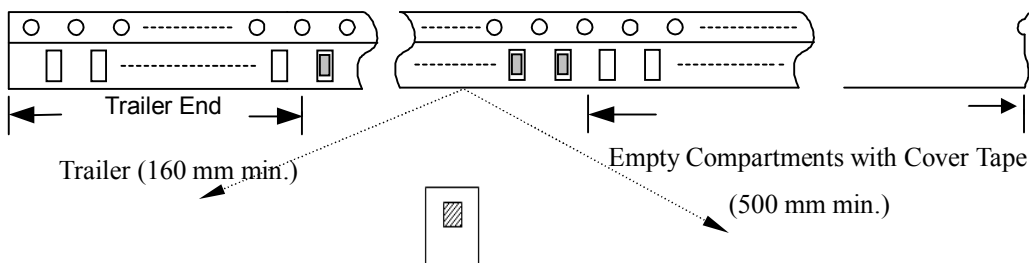

❖ **Peel-off Force**

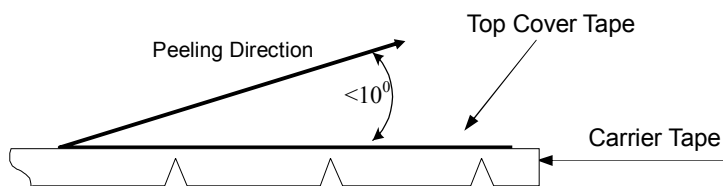

Peel-off force should be in the range of 0.1 – 0.6 N at a peel-off speed of 300 ± 10 mm/min .

❖ **Storage Conditions**

- (1) Temperature: 5 ~35°C , relative humidity (RH): 45~75%.
- (2) Non-corrosive environment

Notes

❖ The contents of this data sheet are subject to change without notice. Please confirm the specifications and delivery conditions when placing your order.

Mechanical & Environmental Characteristics

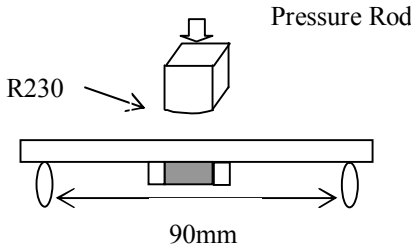
Item	Requirements	Procedure
Solderability	<ol style="list-style-type: none"> No apparent damage More than 95% of the terminal electrode shall be covered with new solder 	<ol style="list-style-type: none"> Preheat: $120 \pm 5^\circ\text{C}$ Solder: $245 \pm 5^\circ\text{C}$ for 5 ± 1 sec
Soldering strength (Termination Adhesion)	<ol style="list-style-type: none"> 10N minimum 	<ol style="list-style-type: none"> Solder specimen onto test jig. Apply push force at 0.5mm/s until electrode pads are peeled off or ceramic are broken. Pushing force is applied to longitude direction
Deflection (Substrate Bending)	<ol style="list-style-type: none"> No apparent damage 	<ol style="list-style-type: none"> Solder specimen onto test jig (FR4, 1.6mm) using the recommend soldering profile. Apply a bending force of 2mm deflection 
Heat/Humidity Resistance	<ol style="list-style-type: none"> No apparent damage Fulfill the electrical specification after test 	<ol style="list-style-type: none"> Temperature: $85 \pm 2^\circ\text{C}$ Humidity: 90% ~ 95% RH Duration: 1000 ± 48hrs Recovery: 1-2hrs
Thermal shock (Temperature Cycle)	<ol style="list-style-type: none"> No apparent damage Fulfill the electrical specification after test 	<ol style="list-style-type: none"> One cycle/step 1 : $125 \pm 5^\circ\text{C}$ for 30 min step 2 : $-40 \pm 5^\circ\text{C}$ for 30 min No of cycles : 100 Recovery: 1-2 hrs
Low Temperature Resistance	<ol style="list-style-type: none"> No apparent damage Fulfill the electrical specification after test 	<ol style="list-style-type: none"> Temperature: $-40 \pm 5^\circ\text{C}$ Duration: 500 ± 24hrs Recovery: 1-2hrs

Soldering Conditions

❖ Typical Soldering Profile for Lead-free Process

Reflow Soldering :

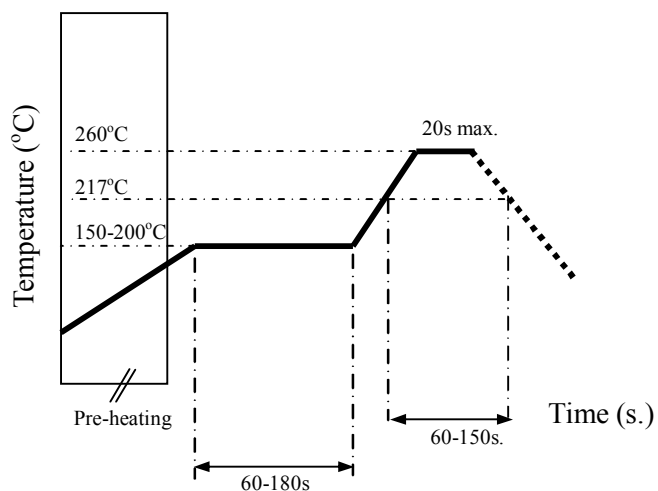

Notes

❖ The contents of this data sheet are subject to change without notice. Please confirm the specifications and delivery conditions when placing your order.

Advanced Ceramic X Corp.

16 Tzu Chiang Road, Hsinchu Industrial District Hsinchu Hsien 303, Taiwan

TEL:886-3-5987008 FAX:886-3-5987001

E-mail: acx@acxc.com.tw

<http://www.acxc.com.tw>