

BF 1608 Series

Multilayer Chip Band-Pass Filters

Features

- ❖ Ultra small SMD type with low loss at pass-band and high attenuation at stop-band.
- ❖ RoHS compliant

Applications

- ❖ 0.8 ~ 6 GHz wireless communication systems, including DECT/PACS/PHS/GSM/DCS phones, WLAN card, Bluetooth modules, Hyper-LAN, etc.

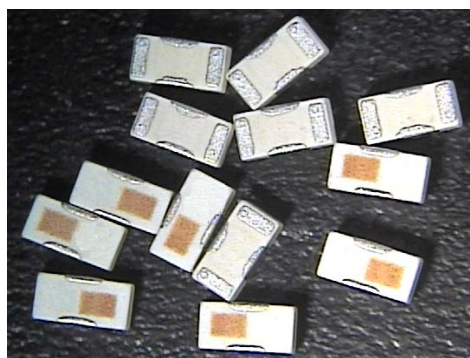

Specifications

Part Number	Freq. Range (MHz)	Insertion Loss @ BW (dB)	VSWR @ BW	Ripple (dB)	Frequency	Attenuation (dB)
BF1608-E5R5TAA_	4900 ~ 5850	1.7 max. @ 4900~5150MHz 1.5 max. @ 5150~5850MHz	2.0 max	0.7max. @ 4900 ~5850MHz (+ 25°C)	824 ~ 960MHz	42.5 min.
					1570 ~ 1580MHz	19.5 min.
					1710 ~ 1910MHz	43.5 min.
					1920 ~ 1990MHz	30.5 min.
					2110 ~ 2170MHz	21.5 min.
					2400 ~ 2500MHz	40 min.
					9800 ~ 11700MHz	25 min.
14700 ~ 17550MHz	10 min.					

Q'ty/Reel (pcs) : 4,000
 Operating Temperature Range : -40 ~ +85 °C
 Storage Temperature Range : -40 ~ +85 °C
 Storage Period : 12 months max.
 Power Capacity : 2W max.

Part Number

BF **1608** - **E** **5R5** **TAA** **□** **/LF**
 ① ② ③ ④ ⑤ ⑥ ⑦

① Type	BF : Band-Pass Filter	② Dimensions (L x W)	1.6 x 0.8 mm
③ Material Code	E	④ Frequency Range	5R5=5400MHz
⑤ Specification Code	TAA	⑥ Packaging	T: Tape & Reel B: Bulk
⑦ Soldering	/LF=lead-free		

Terminal Configuration

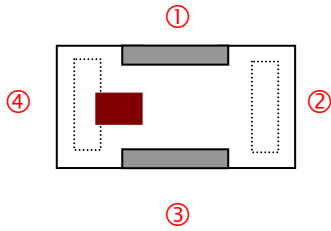

No.	Terminal Name	No.	Terminal Name
①	GND	③	GND
②	OUT	④	IN

Dimensions and Recommended PC Board Pattern

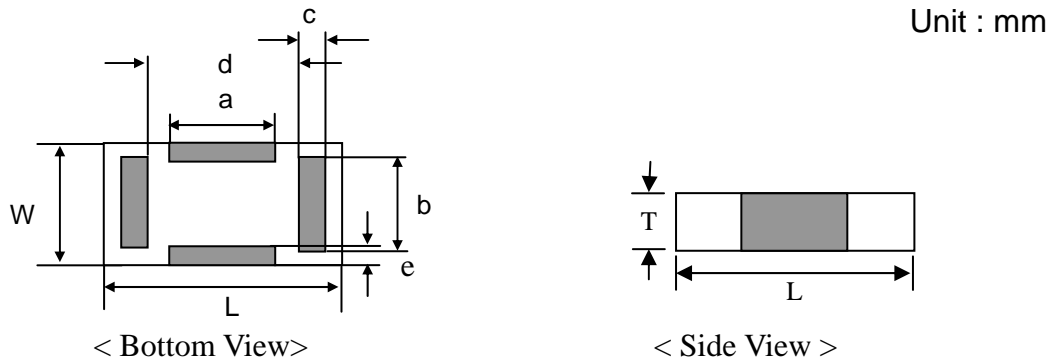

Mark	L	W	T	a	b	c	d	e
Dimensions	1.6 ± 0.10	0.8 ± 0.10	0.6 ± 0.10	0.7 ± 0.15	0.6 ± 0.10	0.2 ± 0.05	1.05 ± 0.10	0.15 ± 0.1

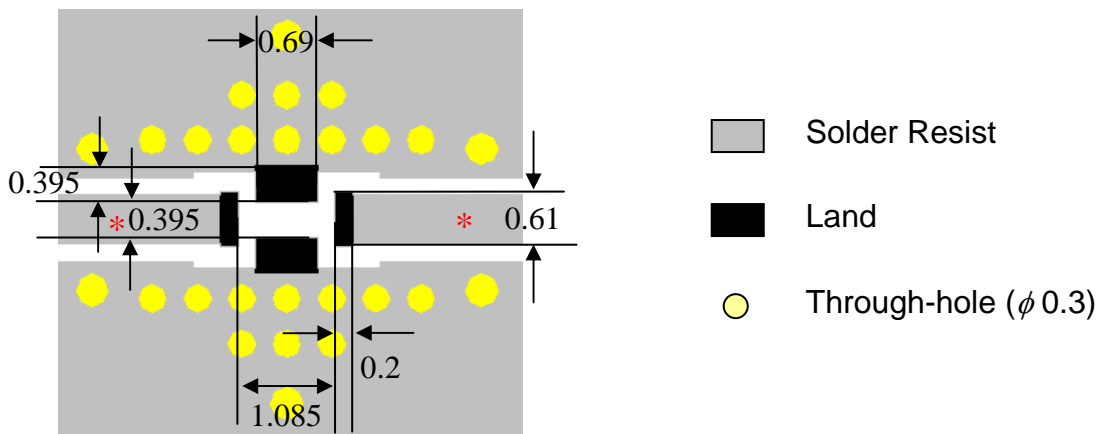

* Line width should be designed to match 50 Ω characteristic impedance, depending on PCB material and thickness.

Measuring Diagram

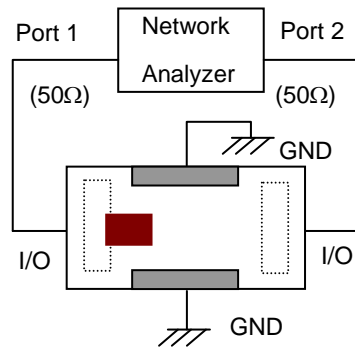

Electrical Characteristics (T=25°C)

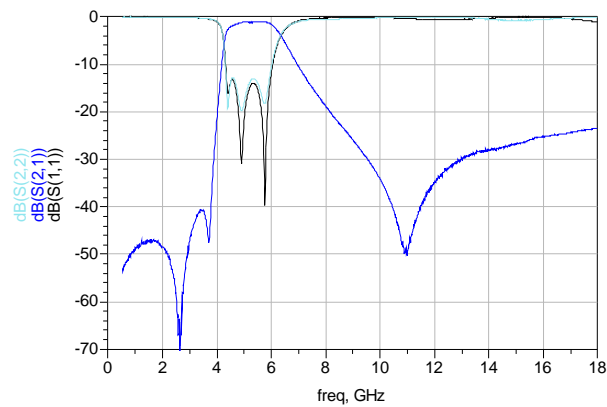

Notes

❖ The contents of this data sheet are subject to change without notice. Please confirm the specifications and delivery conditions when placing your order.

Taping Specifications

❖Tape Dimensions (Unit: mm) & Quantity

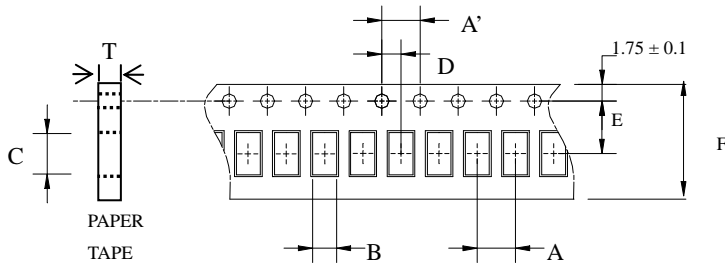

Type	A	A'	B	C	D	E	F	T	Quantity/reel	Tape material
1608	4.0± 0.1	4.0± 0.1	1.10± 0.1	1.92± 0.1	2.0± 0.1	3.5± 0.1	8.0± 0.1	0.75± 0.05	4,000pcs	Paper

❖Reel Dimensions (Unit: mm)

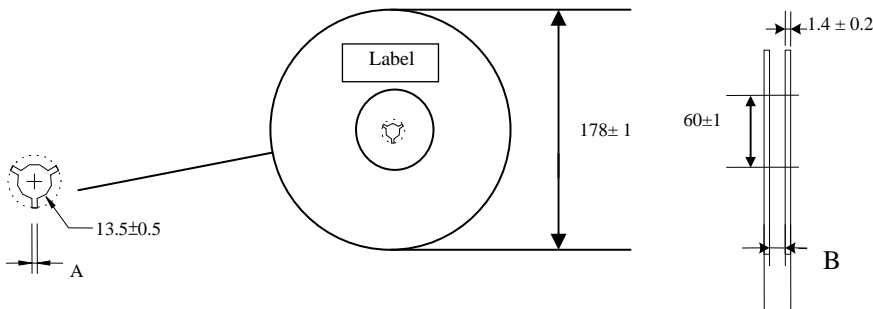

Label: Customer's Name,
ACX P/N, Q'ty, Date,
ACX Corp.

Type	A	B
1608	2.3±0.5	9.0±0.3

❖Leader and Trailer Tape

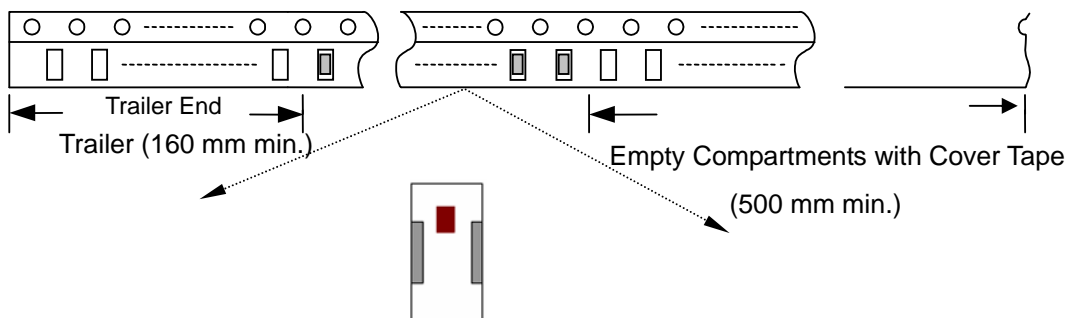

❖ **Peel-off Force**

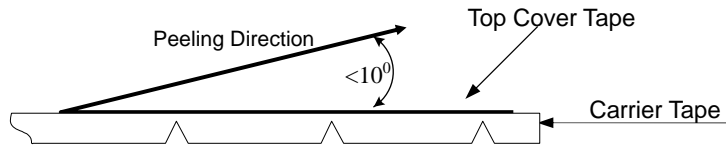

Peel-off force should be in the range of 0.1 – 0.6 N at a peel-off speed of 300 ± 10 mm/min .

❖ **Storage Conditions**

- (1) Temperature: 5 ~35°C , relative humidity (RH): 45~75%.
- (2) Non-corrosive environment.

Notes

- ❖ The contents of this data sheet are subject to change without notice. Please confirm the specifications and delivery conditions when placing your order.

Mechanical & Environmental Characteristics

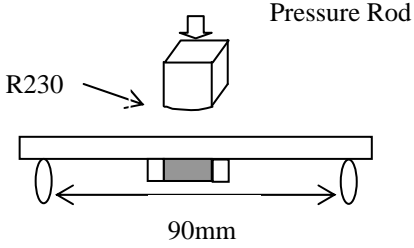
Item	Requirements	Procedure
Solderability	<ol style="list-style-type: none"> No apparent damage More than 95% of the terminal electrode shall be covered with new solder 	<ol style="list-style-type: none"> Preheat: $120 \pm 5^\circ\text{C}$ Solder: $245 \pm 5^\circ\text{C}$ for 5 ± 1 sec
Soldering strength (Termination Adhesion)	<ol style="list-style-type: none"> 1kg minimum 	<ol style="list-style-type: none"> Solder specimen onto test jig. Apply push force at 0.5mm/s until electrode pads are peeled off or ceramic are broken. Pushing force is applied to longitude direction
Deflection (Substrate Bending)	<ol style="list-style-type: none"> No apparent damage 	<ol style="list-style-type: none"> Solder specimen onto test jig (FR4, 0.8mm) using the recommend soldering profile. Apply a bending force of 2mm deflection (Chip length <4.5mm) 
Heat/Humidity Resistance	<ol style="list-style-type: none"> No apparent damage Fulfill the electrical specification after test 	<ol style="list-style-type: none"> Temperature: $85 \pm 2^\circ\text{C}$ Humidity: 90% ~ 95% RH Duration: 1000 ± 48hrs Recovery: 1-2hrs
Thermal shock (Temperature Cycle)	<ol style="list-style-type: none"> No apparent damage Fulfill the electrical specification after test 	<ol style="list-style-type: none"> One cycle/step 1 : $125 \pm 5^\circ\text{C}$ for 30 min step 2 : $-40 \pm 5^\circ\text{C}$ for 30 min No of cycles : 100 Recovery: 1-2 hrs
Low Temperature Resistance	<ol style="list-style-type: none"> No apparent damage Fulfill the electrical specification after test 	<ol style="list-style-type: none"> Temperature: $-40 \pm 5^\circ\text{C}$ Duration: 500 ± 24hrs Recovery: 1-2hrs

Soldering Conditions

❖ Typical Soldering Profile for Lead-free Process

Reflow Soldering :

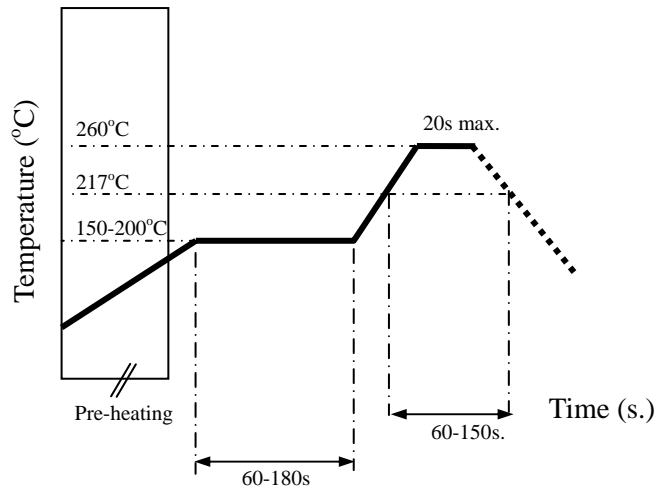

Notes

❖ The contents of this data sheet are subject to change without notice. Please confirm the specifications and delivery conditions when placing your order.

Advanced Ceramic X Corp.

16 Tzu Chiang Road, Hsinchu Industrial District Hsinchu Hsien 303, Taiwan

TEL:886-3-5987008 FAX:886-3-5987001

E-mail: acx@acxc.com.tw <http://www.acxc.com.tw>