

BF 1005 Series

Multilayer Chip Band-Pass Filters



Features

- ❖ Ultra small SMD type with low loss at pass-band and high attenuation at stop-band.
- ❖ RoHS compliant.

Applications

- ❖ Mobile communication systems.

Specifications

Part Number	Freq.Range (MHz)	Insertion Loss @ BW(dB)	Return Loss @ BW(dB)	Frequency (MHz)	Attenuation (dB)
BF1005-N4R7NFC _	4400 ~ 5000	1.5 max.	10 min.	600 ~ 960	35 min.
				1164 ~ 1300	35 min.
				1476 ~ 1511	35 min.
				1559 ~ 1610	35 min.
				1805 ~ 2200	35 min.
				2300 ~ 2690	25 min.
				3055 ~ 3490	20 min.
				8800 ~ 10000	15 min.
				13200 ~ 15000	25 min.
				17600 ~ 20000	20 min.

Q'ty/Reel (pcs) : 10,000
 Operating Temperature Range : -40 ~ +85 °C
 Storage Temperature Range : -40 ~ +85 °C
 Storage Period : 12 months max.
 Power Capacity : 3W max.

Part Number

BF 1005 - N 4R7 NFC □ /LF
 ① ② ③ ④ ⑤ ⑥ ⑦

① Type	BF : Band-Pass Filter	② Dimensions (L × W)	1.0 × 0.5 mm
③ Material Code	N	④ Frequency Range	4R7=4700MHz
⑤ Specification Code	NFC	⑥ Packaging	T: Tape & Reel B: Bulk
⑦ Soldering	/LF=lead-free		

Terminal Configuration

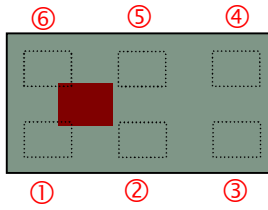

<Top View>

No.	Terminal Name	No.	Terminal Name
①	IN	④	NC
②	GND	⑤	GND
③	OUT	⑥	NC

Dimensions and Recommended PC Board Pattern

Unit: mm

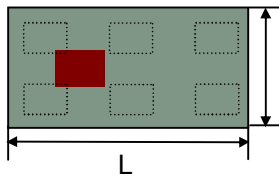

<Top View>

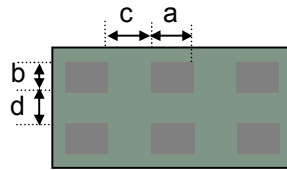

<Bottom View>



<Side View>

Mark	L	W	T	a	b	c	d
Dimensions	1.0 ±0.05	0.5 ±0.05	0.35 Max.	0.18 ±0.05	0.125 ±0.05	0.18 ±0.05	0.15 ±0.05

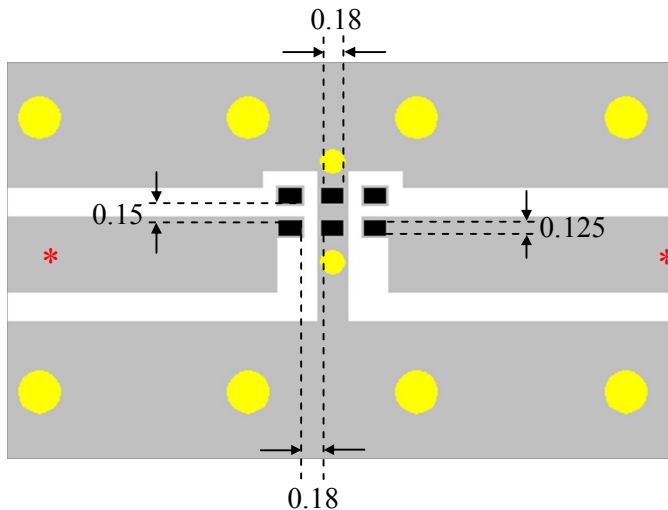

- Solder Resist
- Land
- Through-hole (ϕ 0.35)
- Through-hole (ϕ 0.2)

* Line width should be designed to match 50 Ω characteristic impedance, depending on PCB material and thickness.

Measuring Diagram

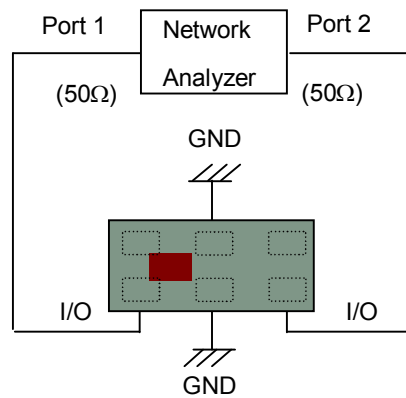

Electrical Characteristics (T=25°C)

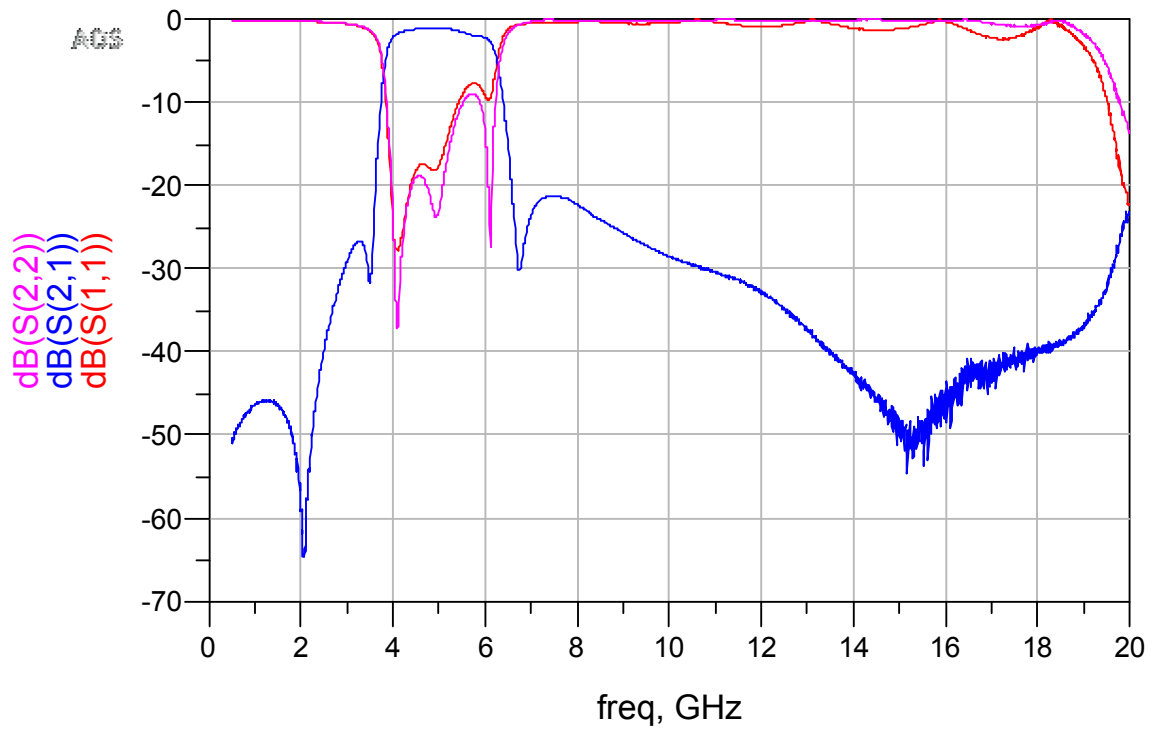

Notes

❖ The contents of this data sheet are subject to change without notice. Please confirm the specifications and delivery conditions when placing your order.

Taping Specifications

❖Tape Dimensions (Unit: mm) & Quantity

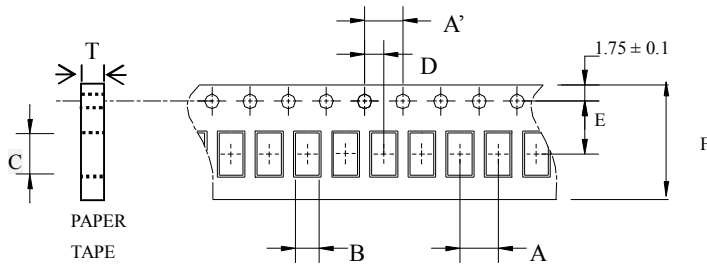

Type	A	A'	B	C	D	E	F	T	Quantity/reel	Tape material
1005	2.0±	4.0±	0.62±	1.12±	2.0±	3.5±	8.0±	0.43±	10,000pcs	Paper
	0.05	0.1	0.03	0.03	0.05	0.05	0.1	0.03		

❖Reel Dimensions (Unit: mm)

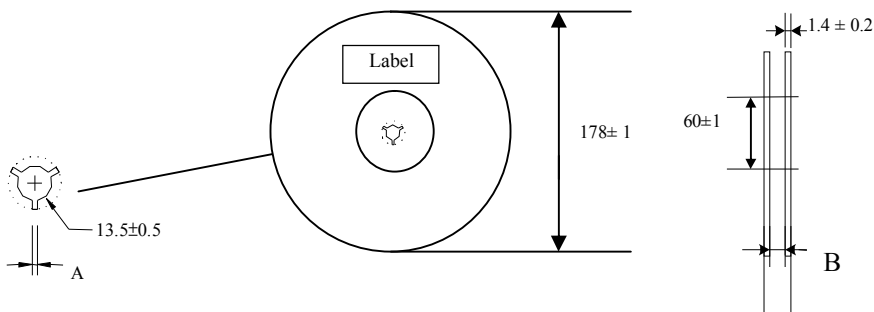

Label: Customer's Name,
ACX P/N, Q'ty, Date,
ACX Corp.

Type	A	B
1005	2.3±0.5	9.0±0.3

❖Leader and Trailer Tape

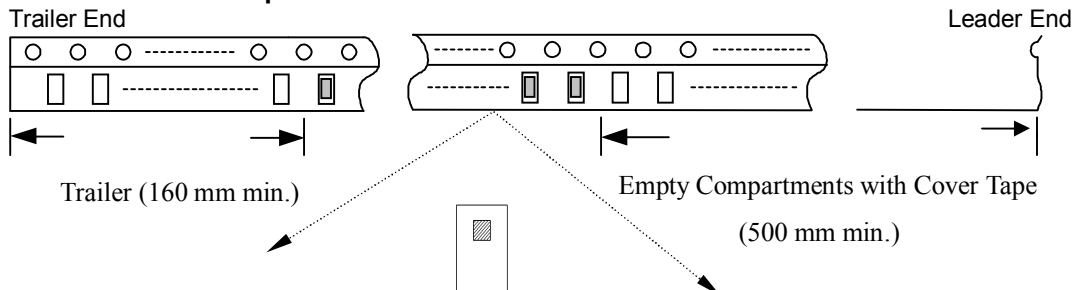

❖ **Peel-off Force**

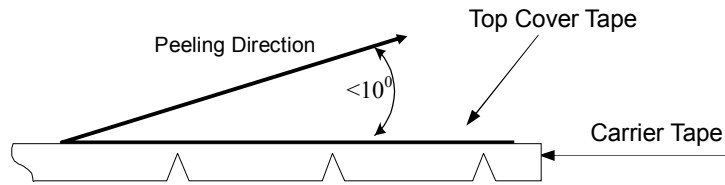

Peel-off force should be in the range of 0.1 – 0.6 N at a peel-off speed of 300 ± 10 mm/min .

❖ **Storage Conditions**

- (1) Temperature: 5 ~35°C , relative humidity (RH): 45~75%.
- (2) Non-corrosive environment.

Notes

- ❖ The contents of this data sheet are subject to change without notice. Please confirm the specifications and delivery conditions when placing your order.

Mechanical & Environmental Characteristics

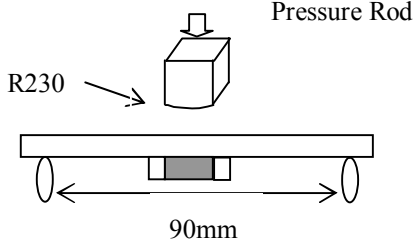
Item	Requirements	Procedure
Solderability	<ol style="list-style-type: none"> No apparent damage More than 95% of the terminal electrode shall be covered with new solder. 	<ol style="list-style-type: none"> Preheat: $120 \pm 5^\circ\text{C}$ Solder: $245 \pm 5^\circ\text{C}$ for 5 ± 1 sec
Soldering strength (Termination Adhesion)	<ol style="list-style-type: none"> 3N minimum 	<ol style="list-style-type: none"> Solder specimen onto test jig. Apply push force at 0.5mm/s until electrode pads are peeled off or ceramic are broken. Pushing force is applied to longitude direction
Deflection (Substrate Bending)	<ol style="list-style-type: none"> No apparent damage 	<ol style="list-style-type: none"> Solder specimen onto test jig (FR4, 1.6mm) using the recommend soldering profile. Apply a bending force of 2mm deflection 
Heat/Humidity Resistance	<ol style="list-style-type: none"> No apparent damage Fulfill the electrical specification after test 	<ol style="list-style-type: none"> Temperature: $85 \pm 2^\circ\text{C}$ Humidity: 90% ~ 95% RH Duration: 1000 ± 48hrs Recovery: 1-2hrs
Thermal shock (Temperature Cycle)	<ol style="list-style-type: none"> No apparent damage Fulfill the electrical specification after test 	<ol style="list-style-type: none"> One cycle/step 1 : $125 \pm 5^\circ\text{C}$ for 30 min step 2 : $-40 \pm 5^\circ\text{C}$ for 30 min No of cycles : 100 Recovery: 1-2 hrs
Low Temperature Resistance	<ol style="list-style-type: none"> No apparent damage Fulfill the electrical specification after test 	<ol style="list-style-type: none"> Temperature: $-40 \pm 5^\circ\text{C}$ Duration: 500 ± 24hrs Recovery: 1-2hrs

Soldering Conditions

❖ Typical Soldering Profile for Lead-free Process

Reflow Soldering :

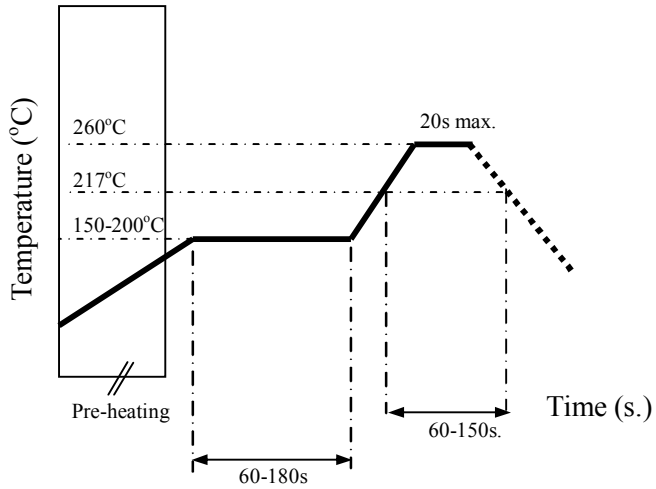

Notes

❖ The contents of this data sheet are subject to change without notice. Please confirm the specifications and delivery conditions when placing your order.

Advanced Ceramic X Corp.

16 Tzu Chiang Road, Hsinchu Industrial District Hsinchu Hsien 303, Taiwan

TEL:886-3-5987008 FAX:886-3-5987001

E-mail: acx@acxc.com.tw

<http://www.acxc.com.tw>